

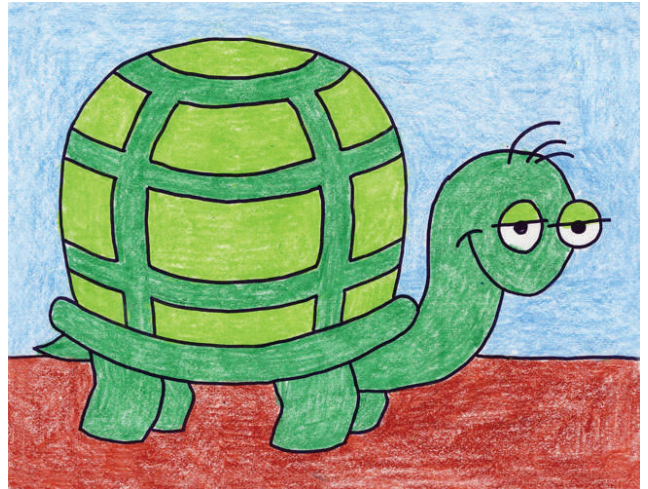

Cartoon Drawing for Kids

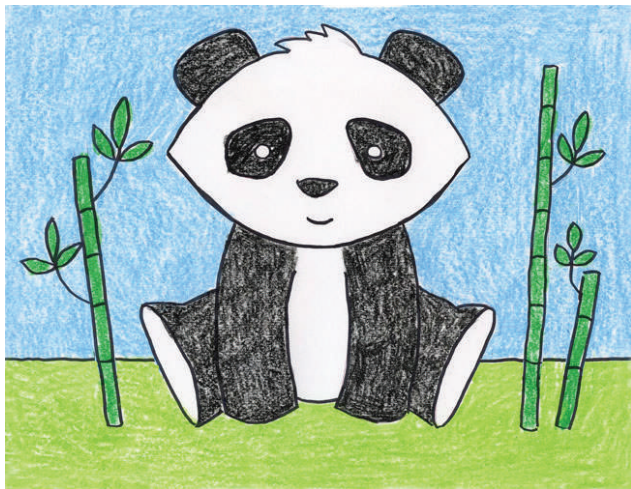

© www.artprojectsforkids.org

A collection of 25 drawing projects from Art Projects for Kids.org

Table of Contents

1. Alligator	page 3-4
2. Ballerina	page 5-6
3. Black Cat	page 7-8
4. Young Boy	page 9-10
5. Car	page 11-12
6. Dog	page 13-14
7. Fox	page 15-16
8. French Girl	page 17-18
9. Giraffe	page 19-20
10. Guy	page 21-22
11. Hamster	page 23-24
12. Kimono Girl	page 25-26
13. Lady	page 27-28
14. Mouse	page 29-30
15. Pajama Girl	page 31-32
16. Panda Bear	page 33-34
17. Penguin	page 35-36
18. Pigtail Girl	page 37-38
19. Princess	page 39-40
20. Sheep	page 41-42
21. Smart Guy	page 43-44
22. Sombrero Boy	page 45-46
23. Tugboat	page 47-48
24. Turtle	page 49-50
25. Cartoon Heads	page 51
Paper with grid lines, divided in quarters	page 52
Paper with grid lines, divided in eighths	page 53

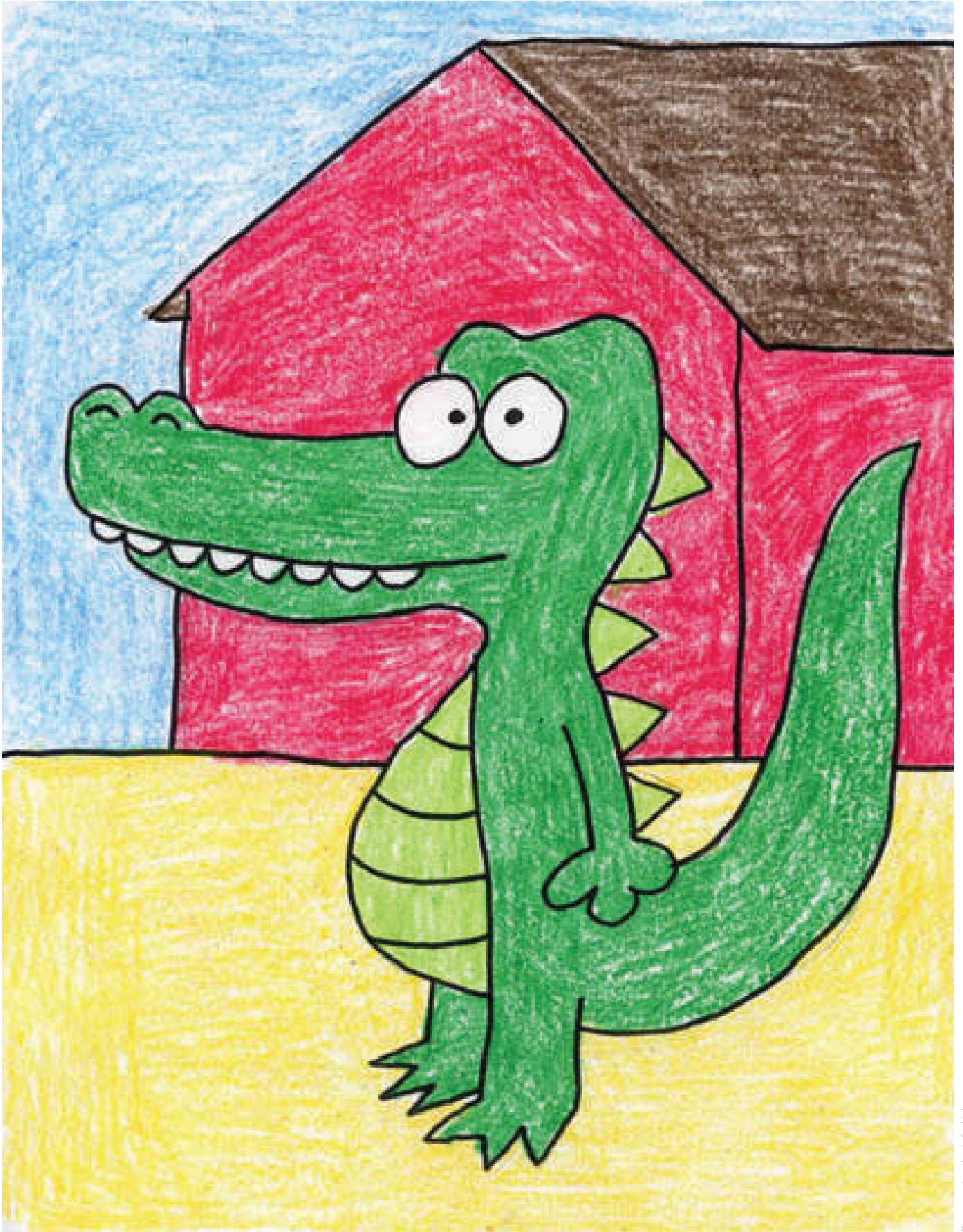

Alligator

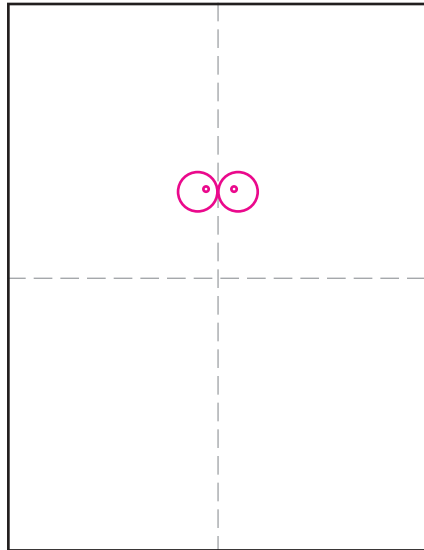

1. Make fold lines. Draw two eyes.

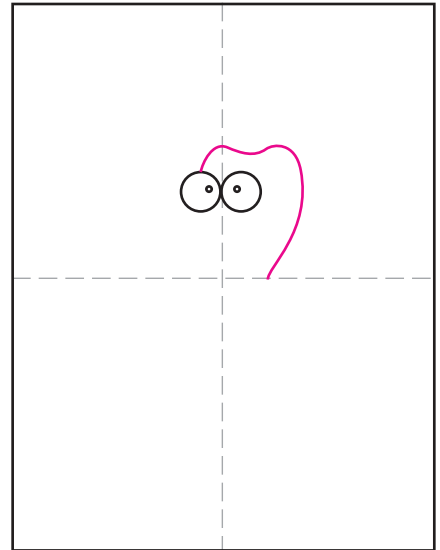

2. Draw head around eyes.

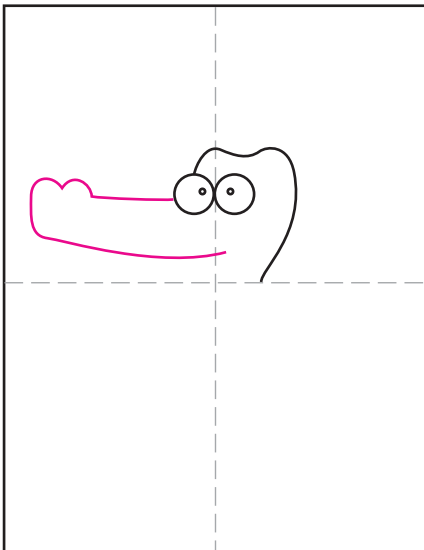

3. Add nose and mouth line.

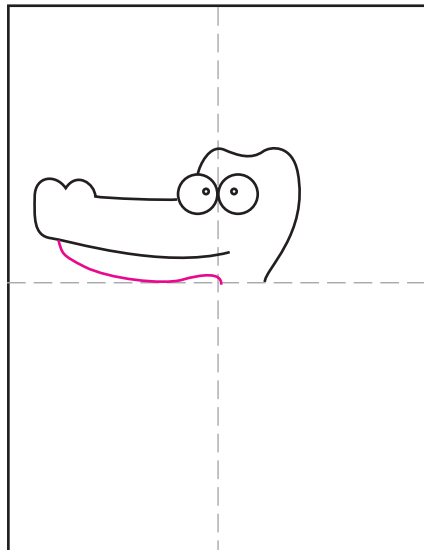

4. Draw bottom of mouth.

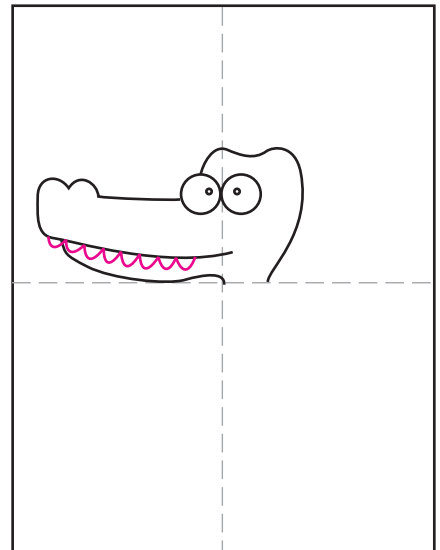

5. Add curved teeth.

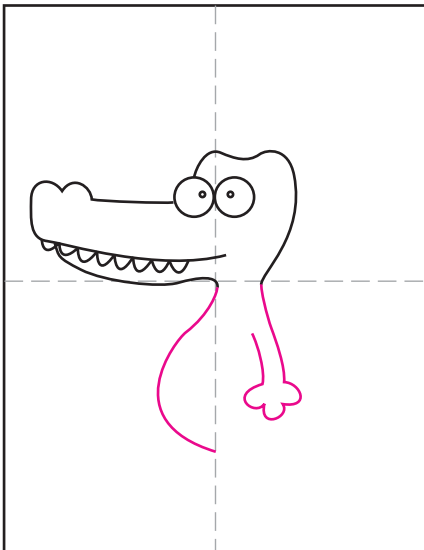

6. Draw belly and arm.

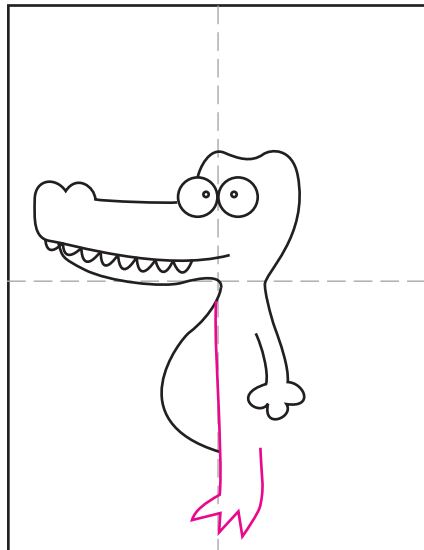

7. Add line with foot.

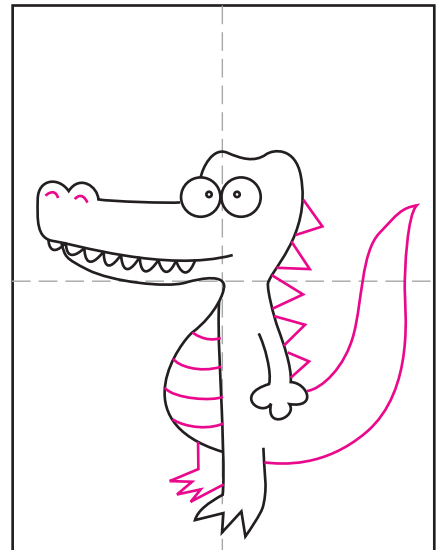

8. Draw other foot, tail, and details.



Ballerina

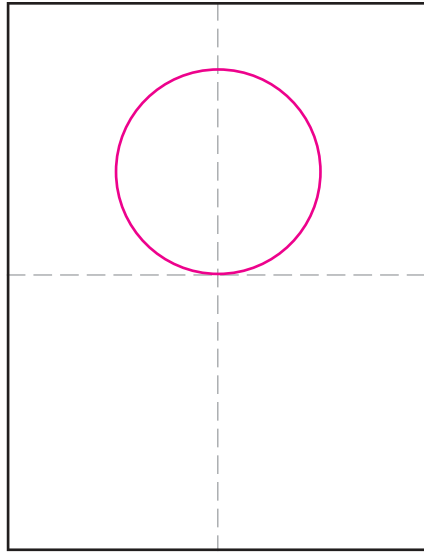

1. Make guide lines. Draw a circle.

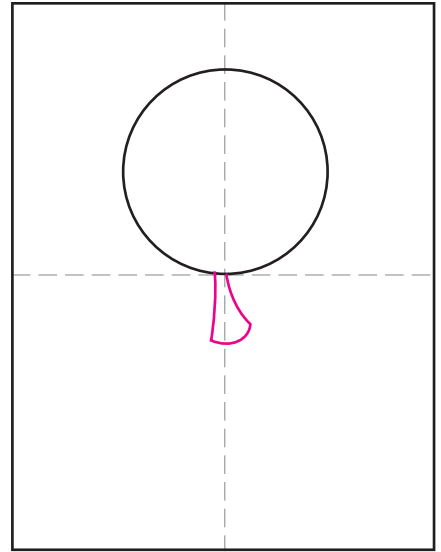

2. Add a simple body.

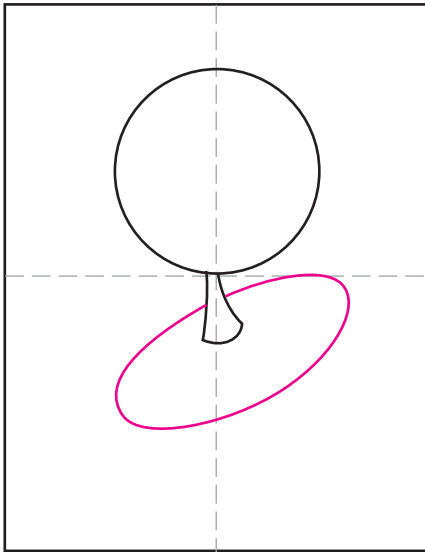

3. Draw an oval for the skirt.

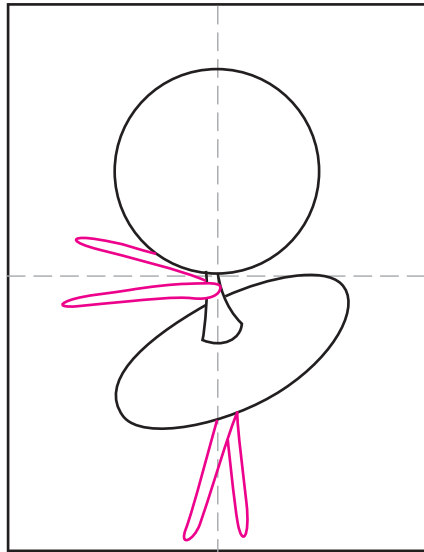

4. Draw simple legs and arms.

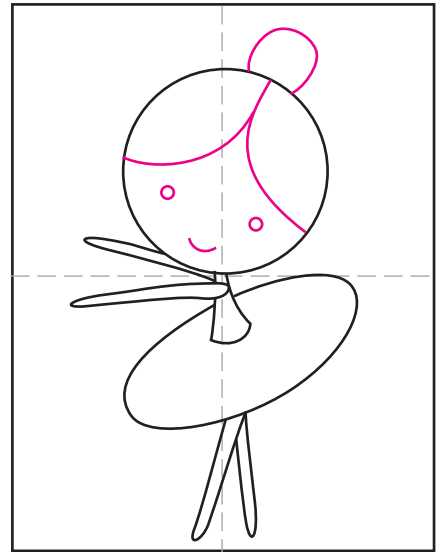

5. Add the face and hair lines.

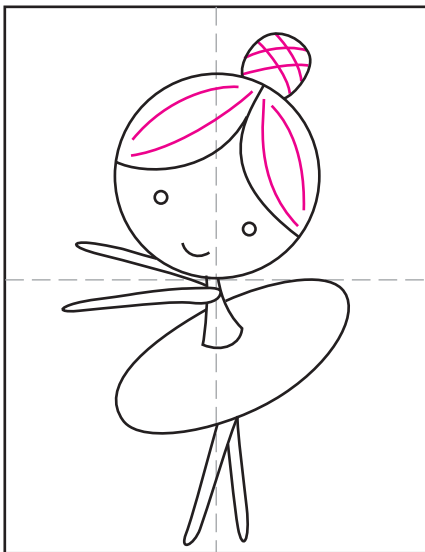

6. Draw the hair lines.

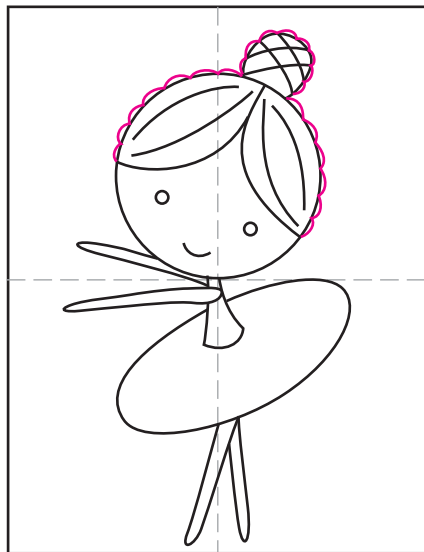

7. Add scallops along hair line.

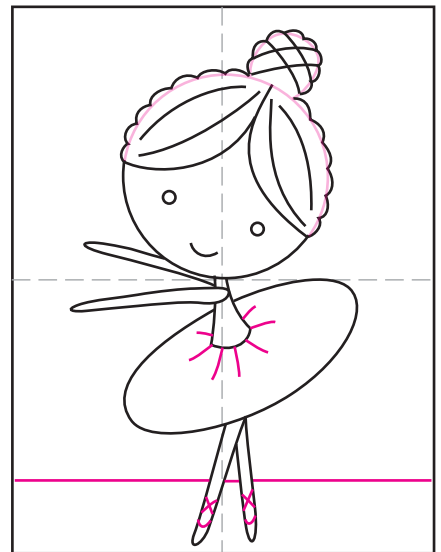

8. Finish skirt, shoe, floor lines.



Black Cat

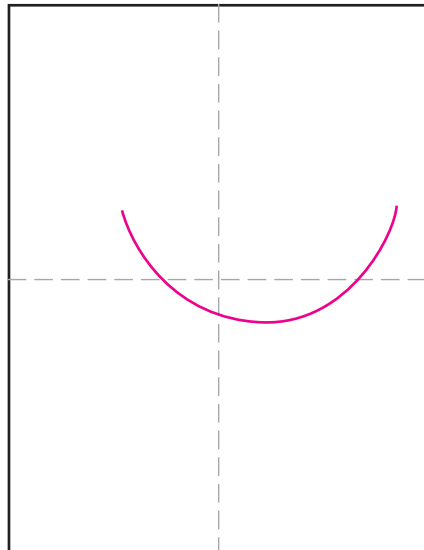

1. Make fold lines. Draw a curve.

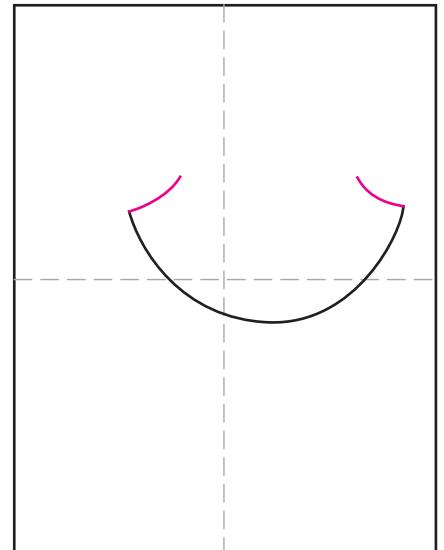

2. Begin the top of the head.

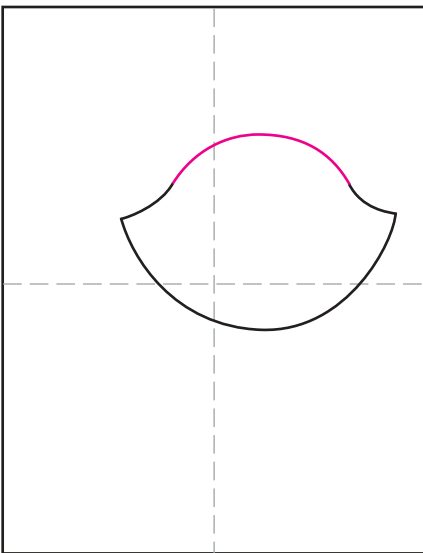

3. Finish the top head.

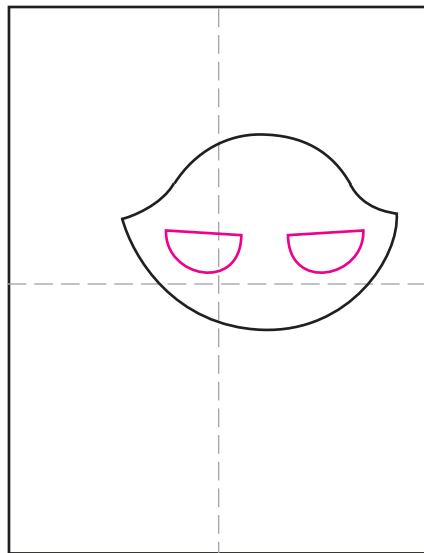

4. Draw two half circle eyes.

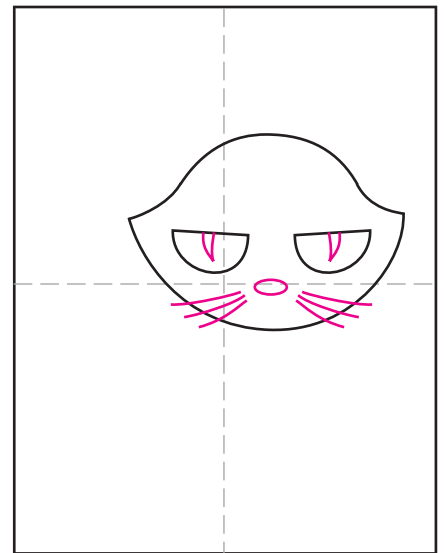

5. Draw inside eye, nose, whiskers.

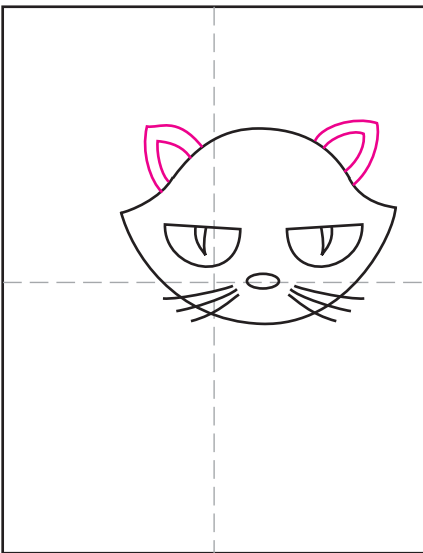

6. Add two ears.

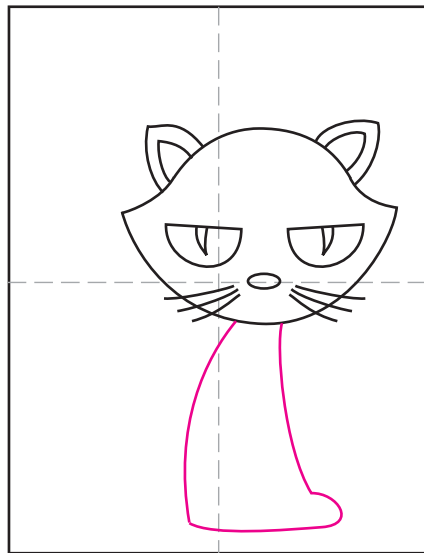

7. Draw the outside of the body

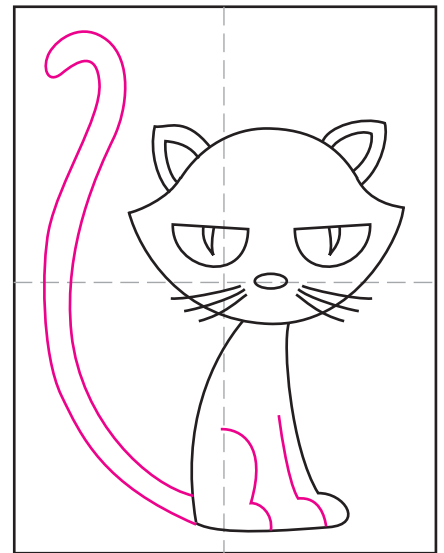

8. Add leg lines and long tail.



Young Boy

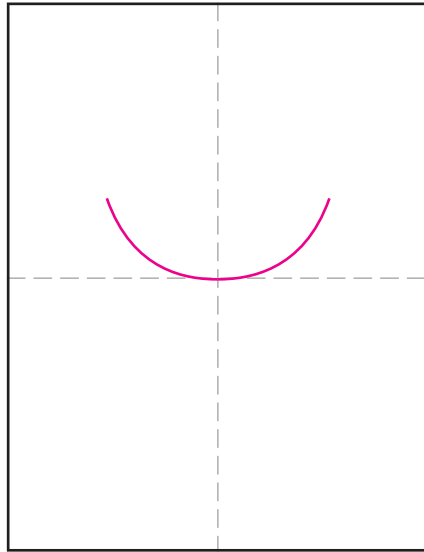

1. Make guide lines. Start the face.

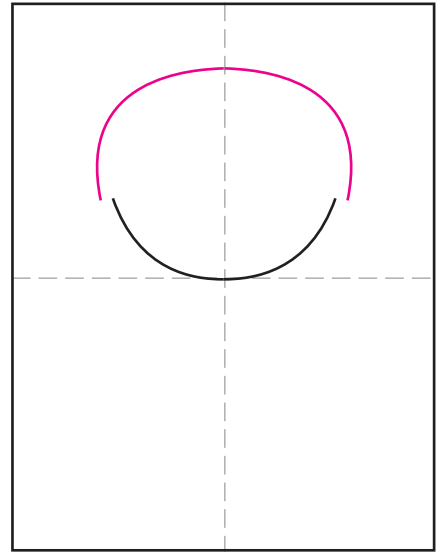

2. Add the top hair line.

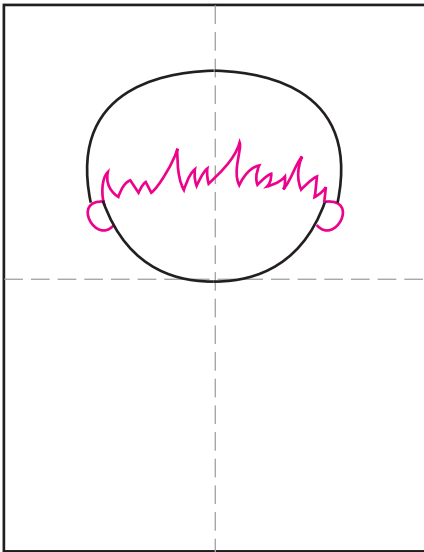

3. Add ears and bangs line.

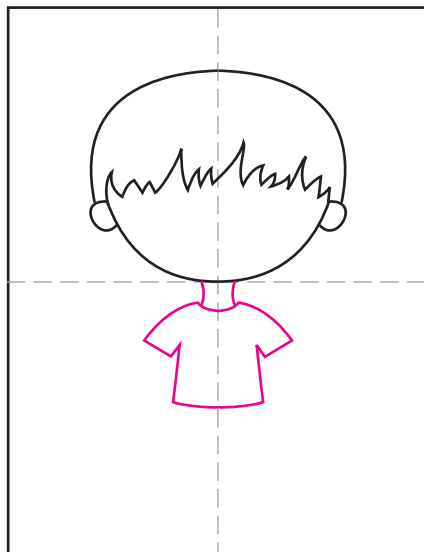

4. Add a small neck and shirt.

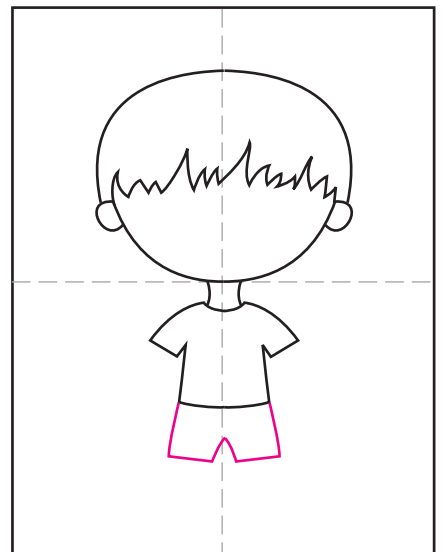

5. Add shorts below.

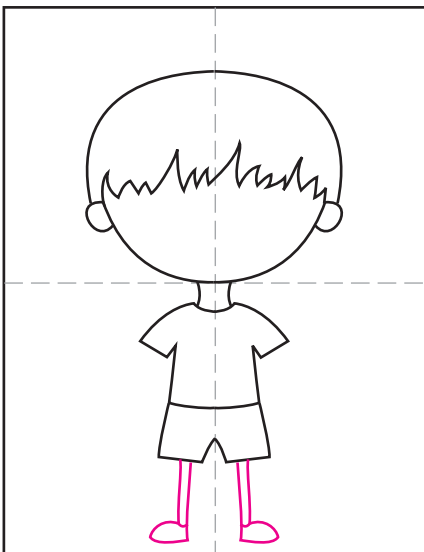

6. Draw legs and feet.

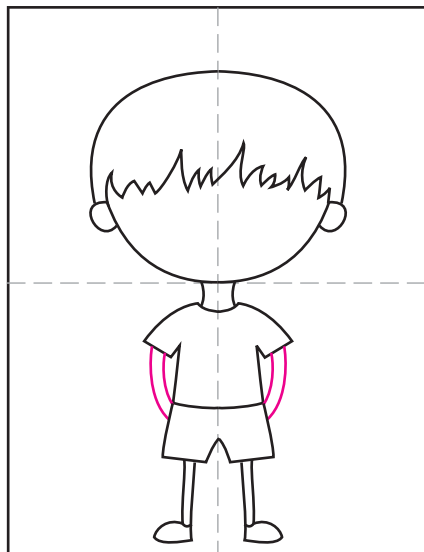

7. Add the arms.



8. Finish with face and hair details.

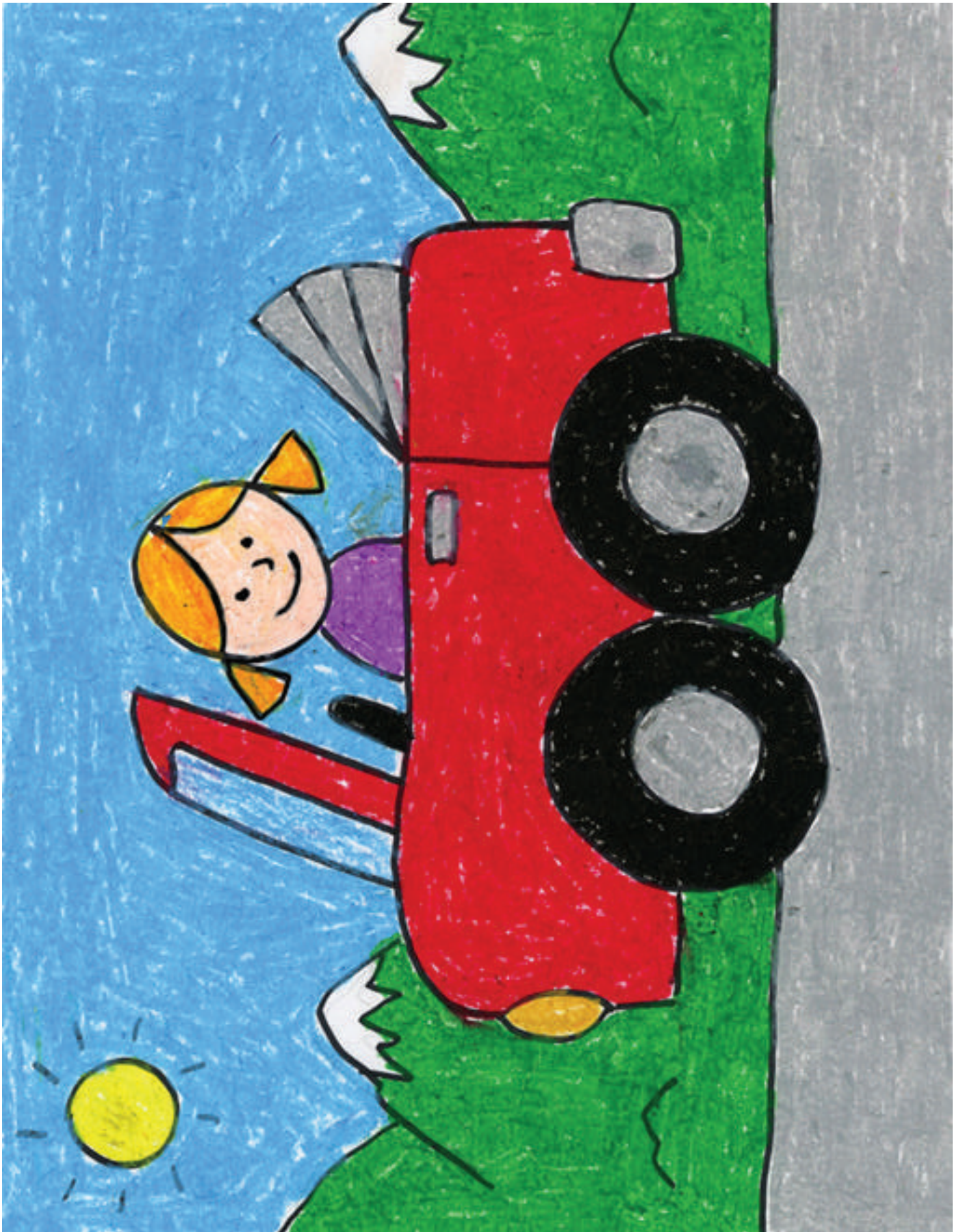

Car

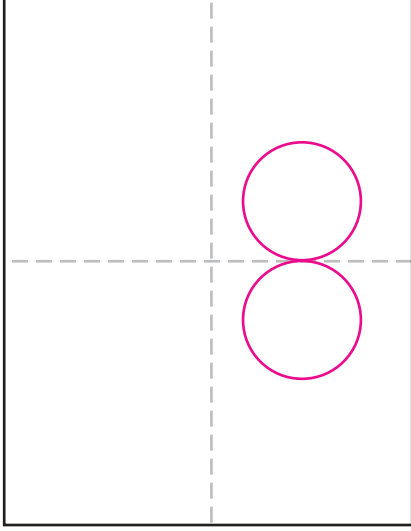
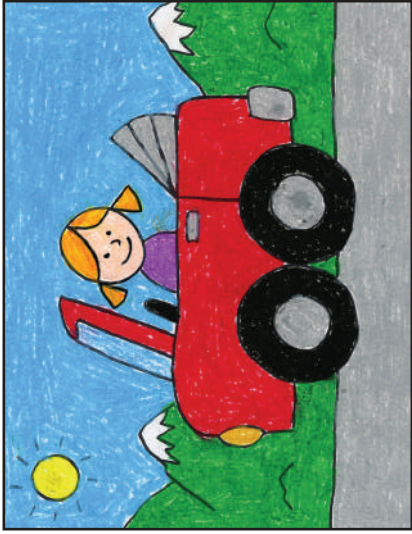

1. Make guide lines. Draw two circle tires.

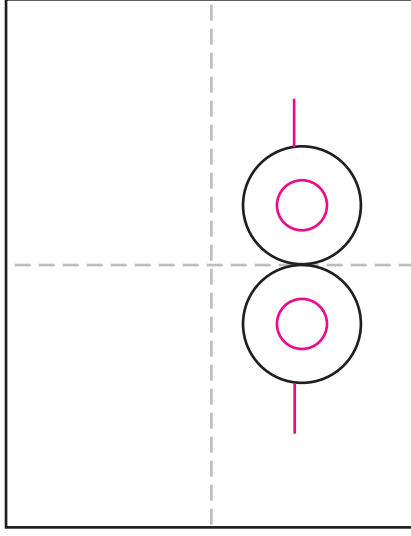

2. Add tire centers and two lines.

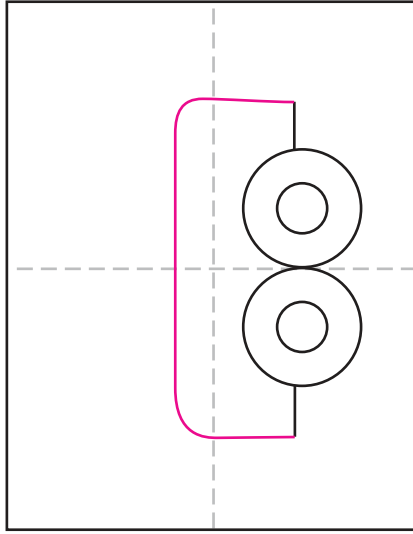

3. Finish the car body as shown.

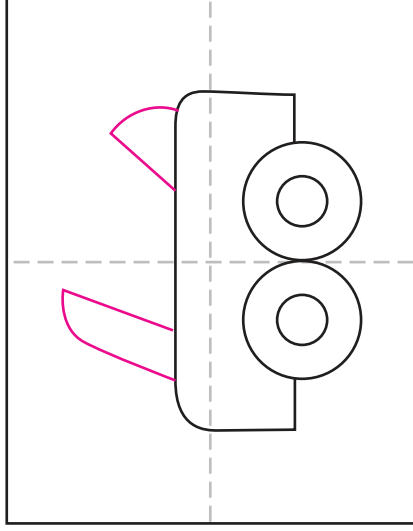

4. Draw the windshield and folded top.

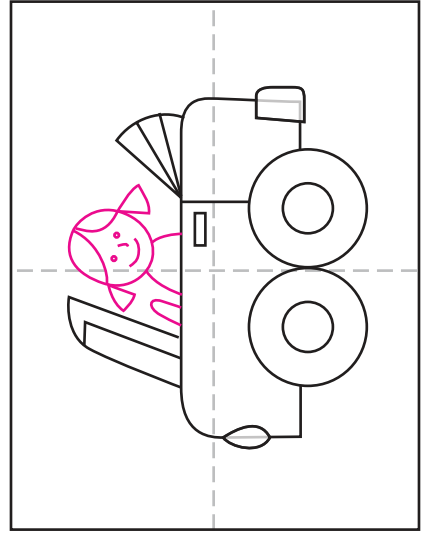

6. Draw a person and steering wheel.

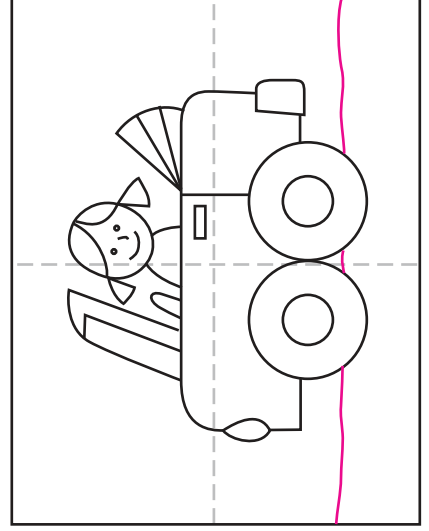

7. Add the ground line.

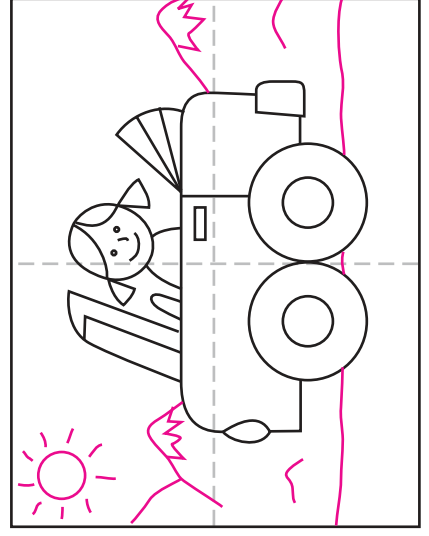

8. Finish with mountain background and sun.

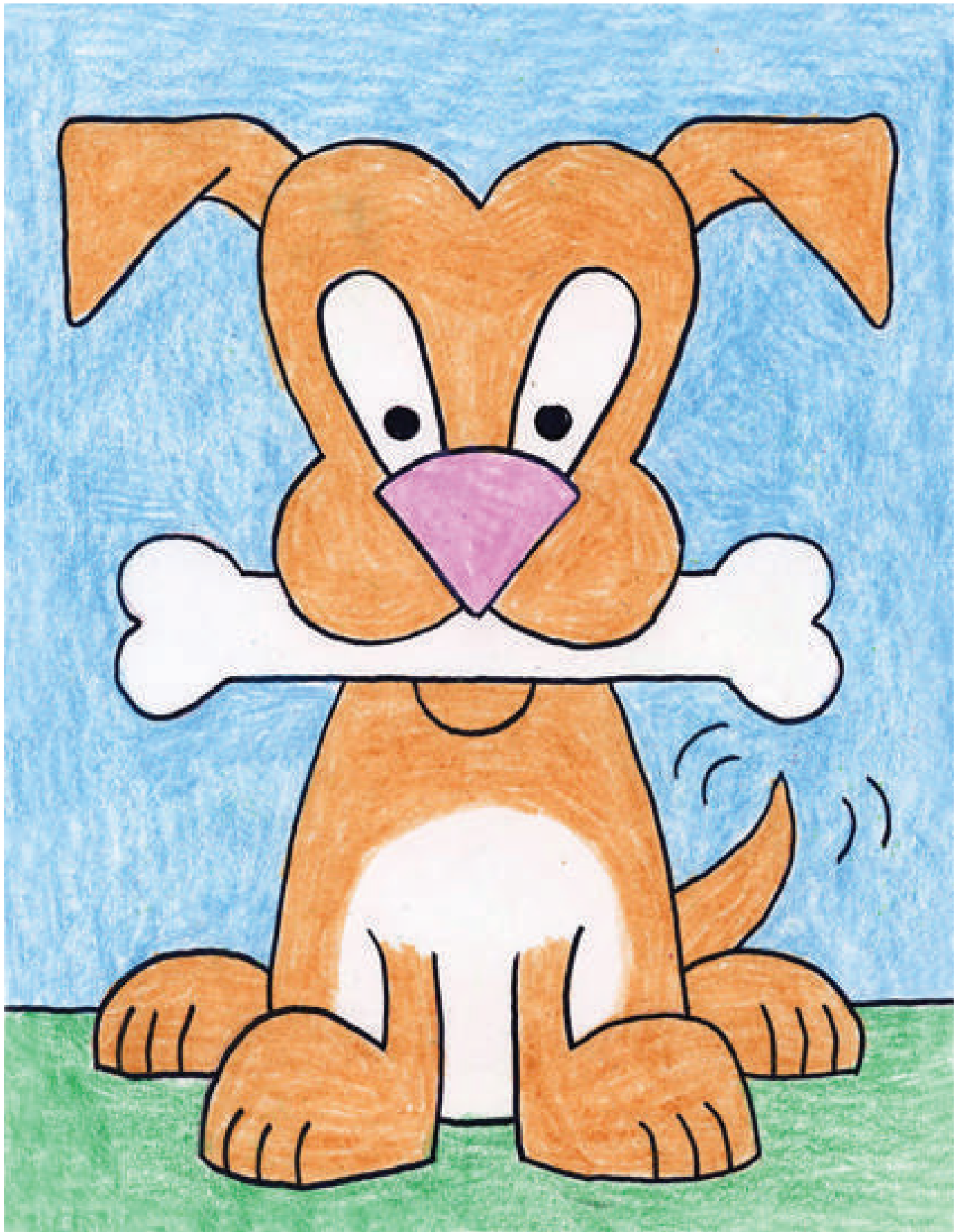

Dog

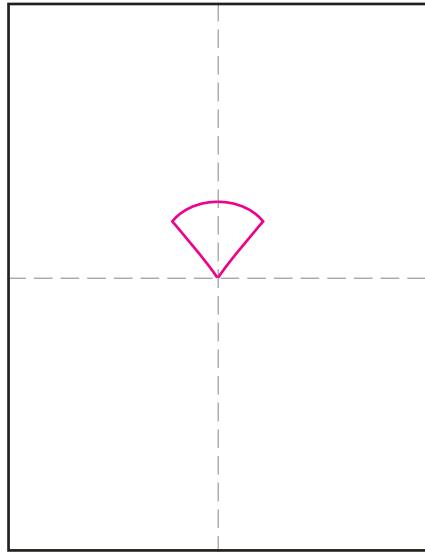

1. Make guide lines. Draw the nose.

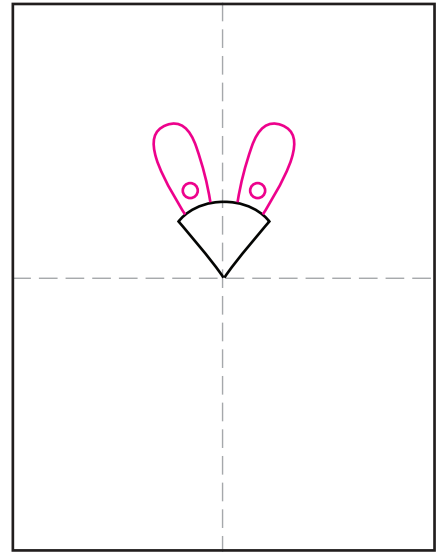

2. Draw two eyes.

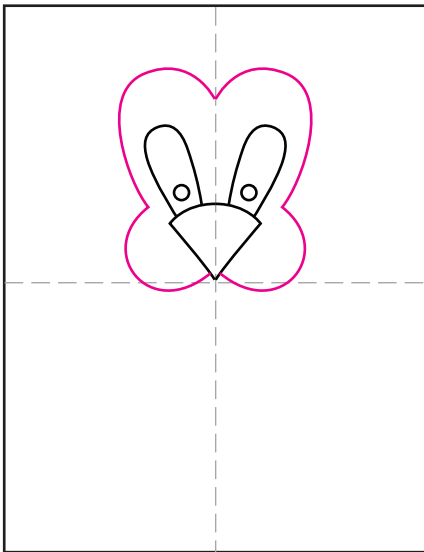

3. Draw face around eyes and nose.

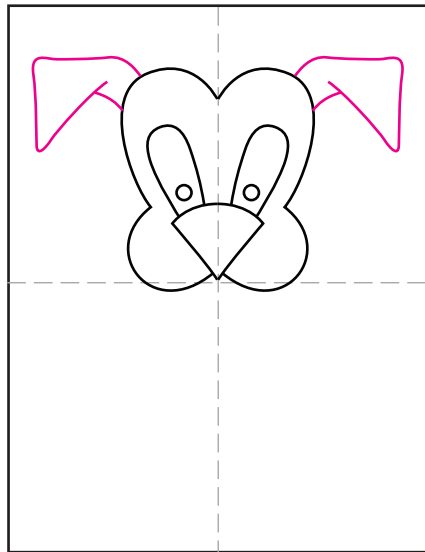

4. Draw two folded ears.

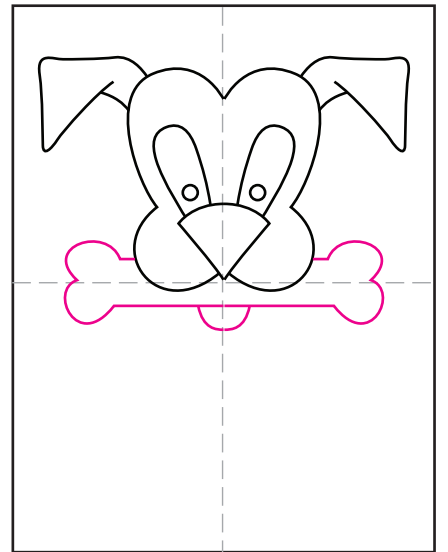

5. Draw bone and chin.

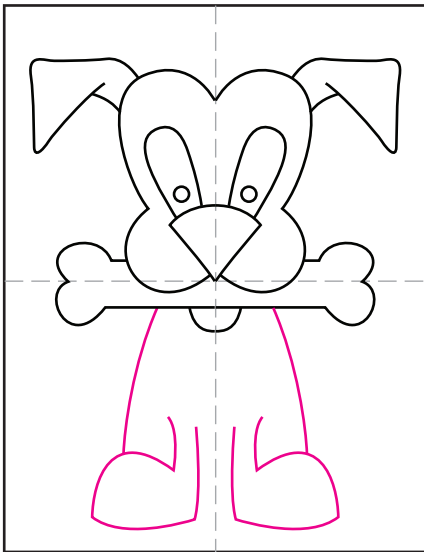

6. Add sides and front legs.

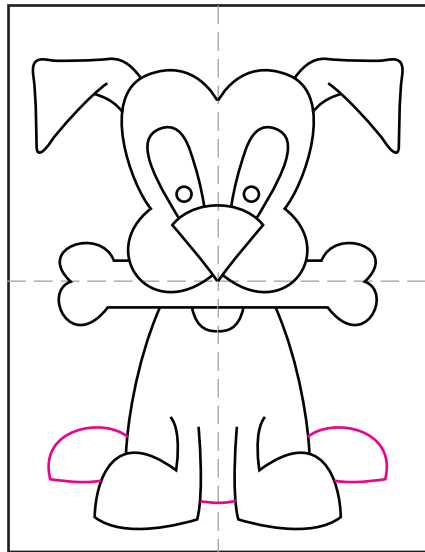

7. Add back feet and belly line.

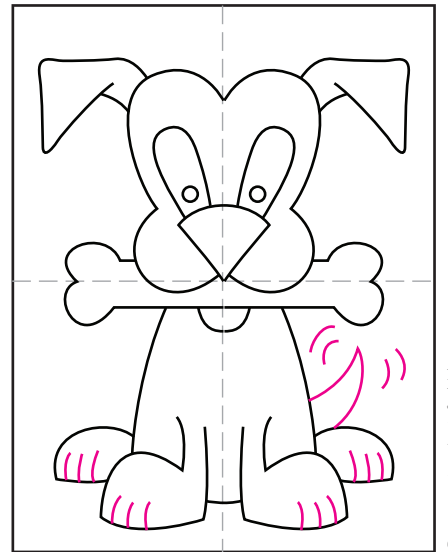

8. Finish with toenails and tail.



Fox

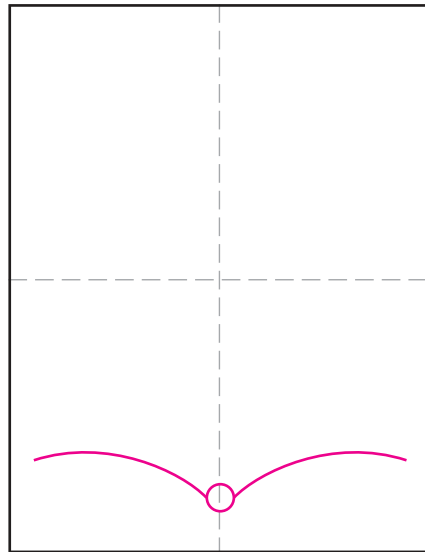

1. Draw circle and two curves.

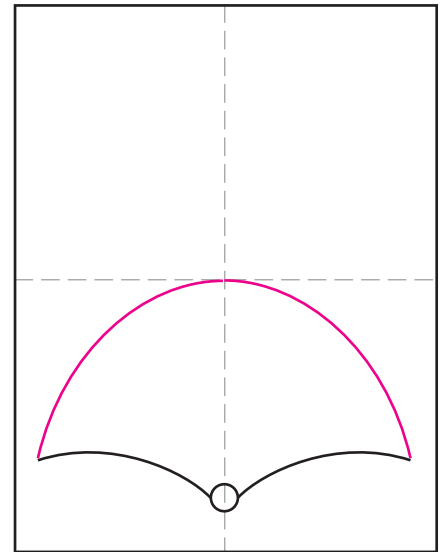

2. Draw top curve of head.

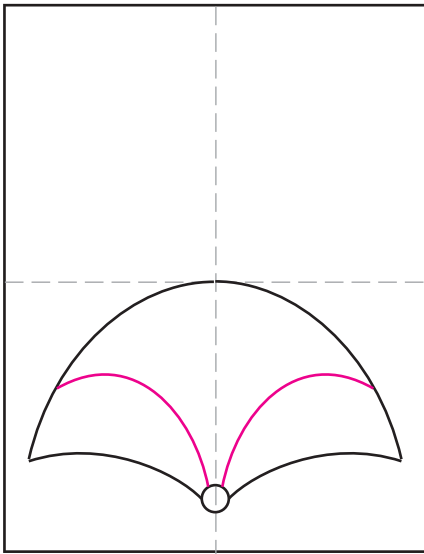

3. Add two more matching curves.

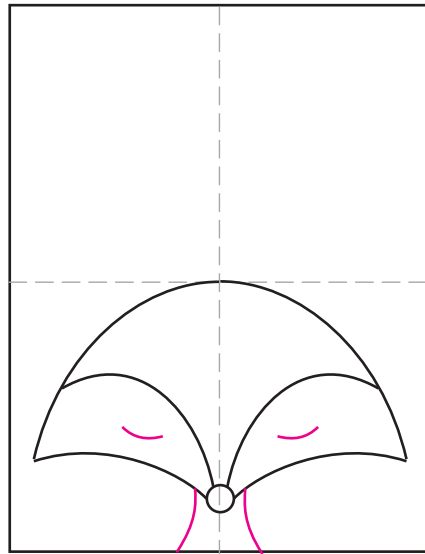

4. Add the eyes and skinny neck.

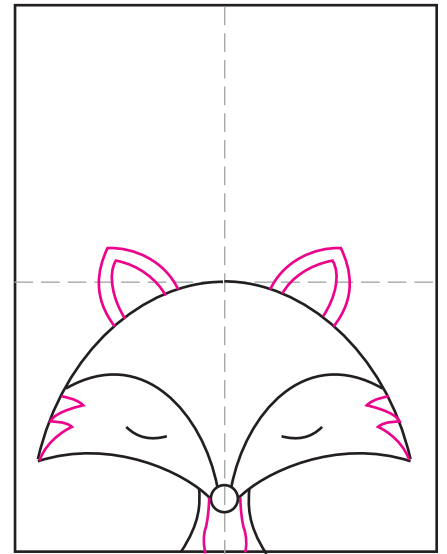

5. Draw zig-zag lines, chest, ears.



6. Add large tail behind head.



7. Draw trees, smaller and smaller.

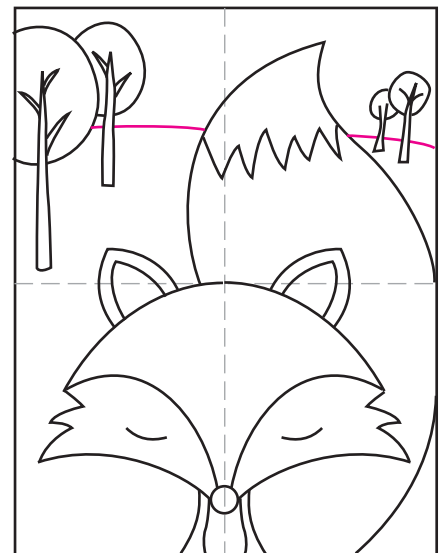

8. Add horizon line through trunks.



French Girl

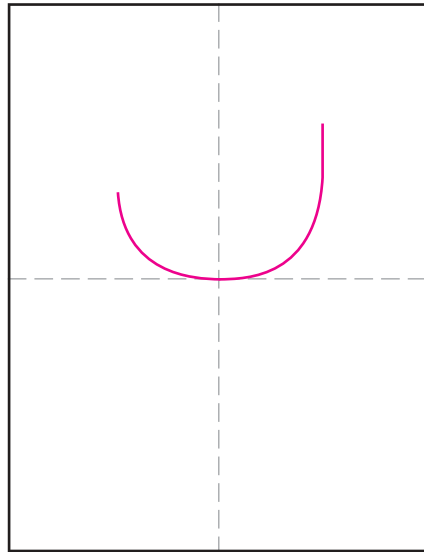

1. Make guide lines. Start the face.

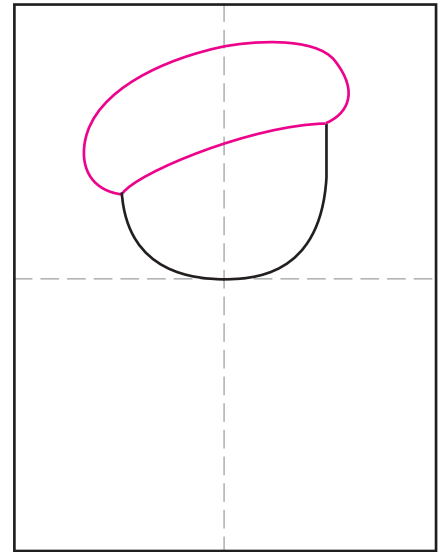

2. Draw the angled hat.

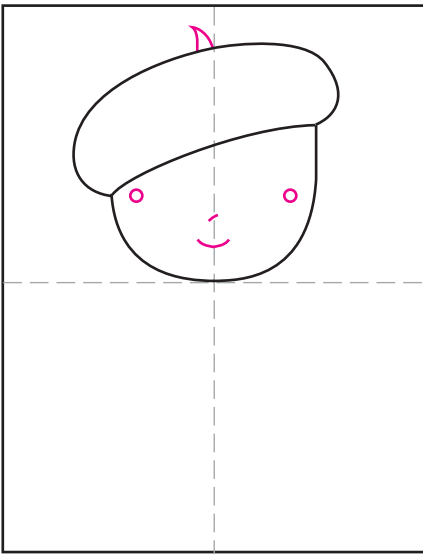

3. Add hat and face details.

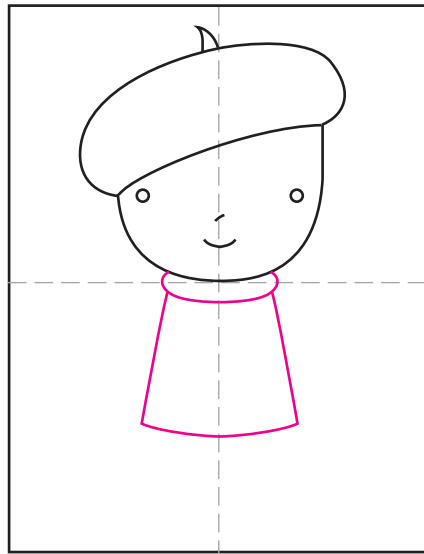

4. Start the scarf and shirt.

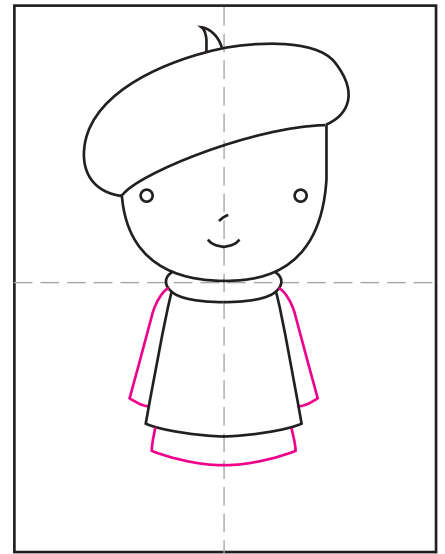

5. Add the sleeves and skirt.

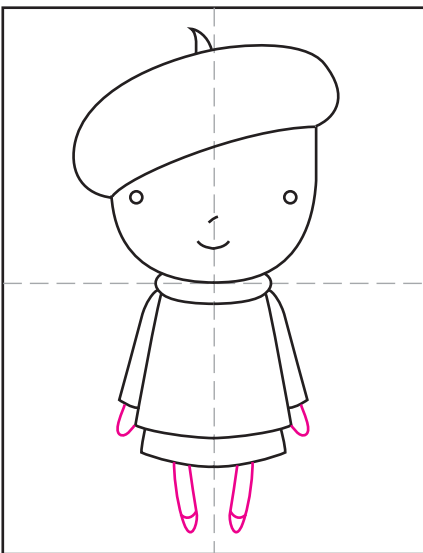

6. Add hands, legs and shoes.

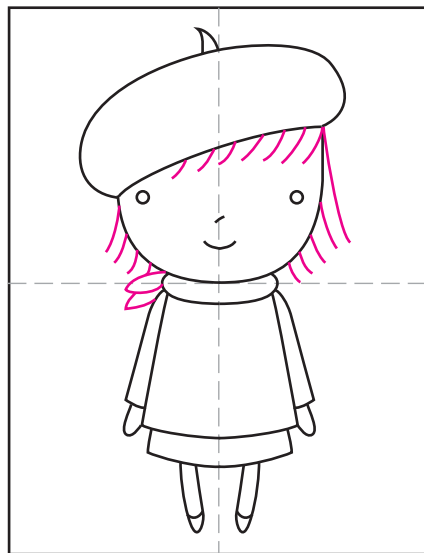

7. Finish scarf and draw hair lines.

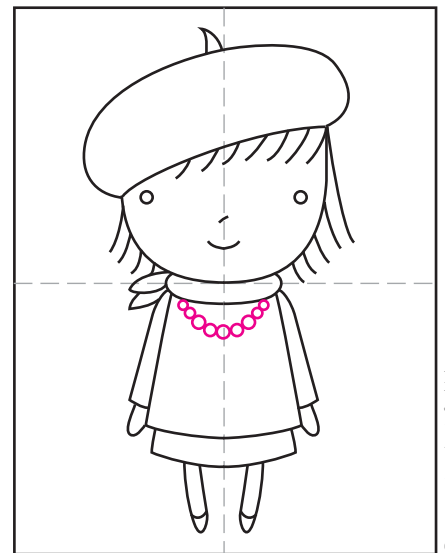

8. Finish with a bead necklace.

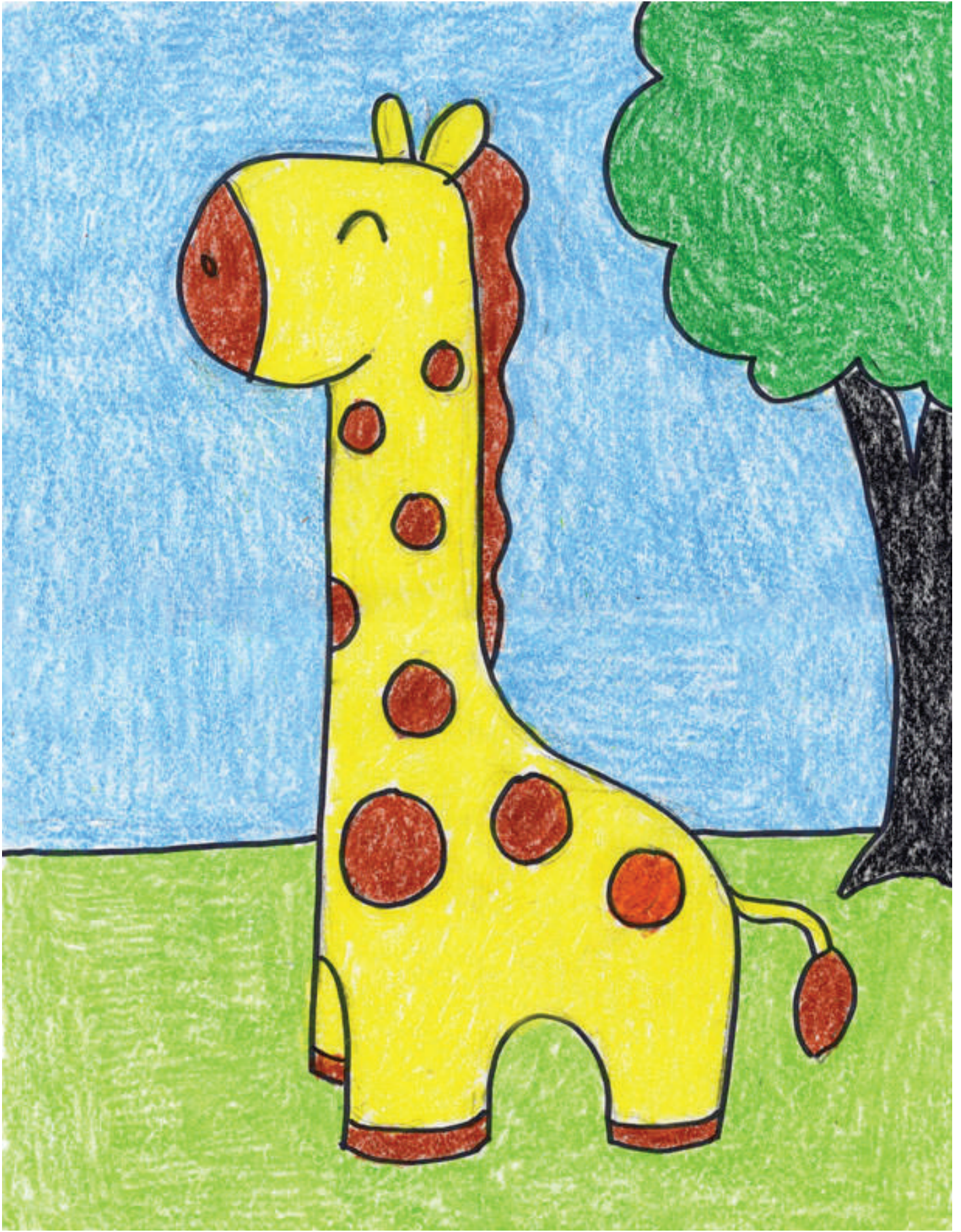

Giraffe

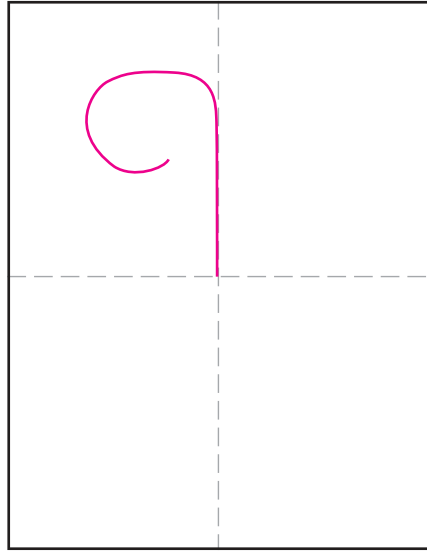

1. Make guide lines. Start the head.

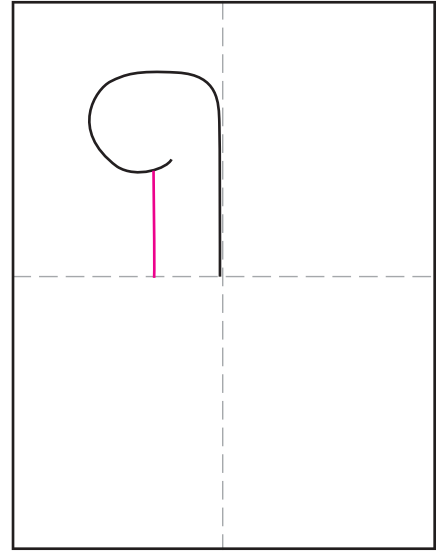

2. Add the front neck.

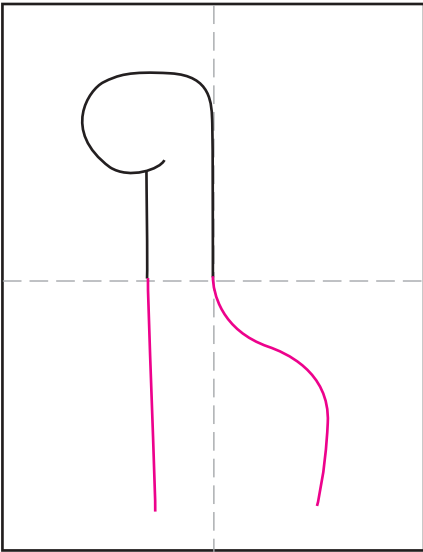

3. Continue lines down for legs.

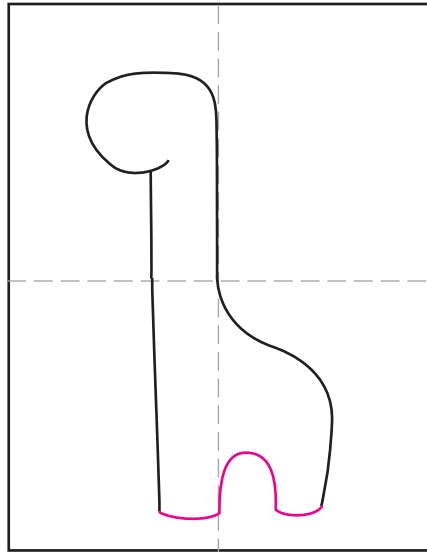

4. Add inside leg line.

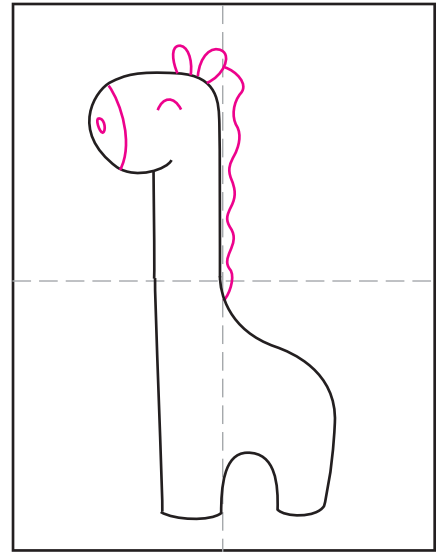

5. Draw face, ears and mane.

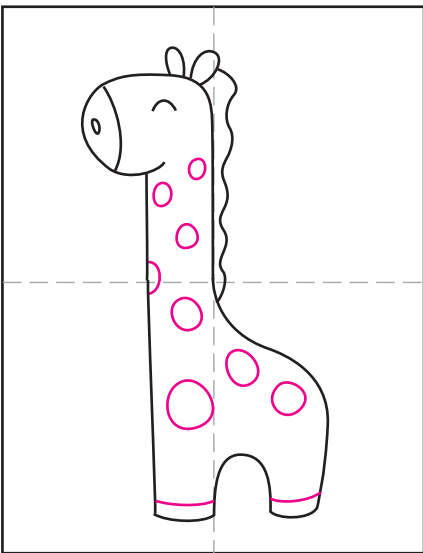

6. Add the spots and hoofs.

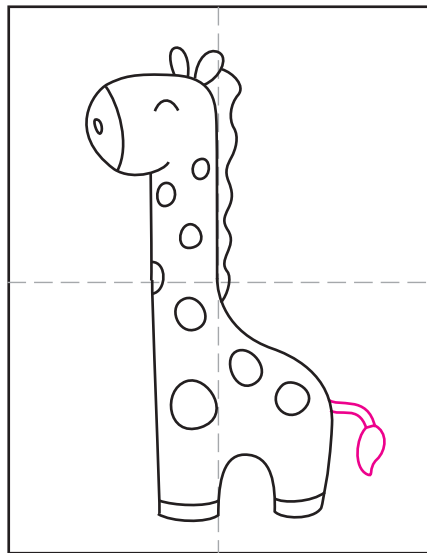

7. Draw tail in back.

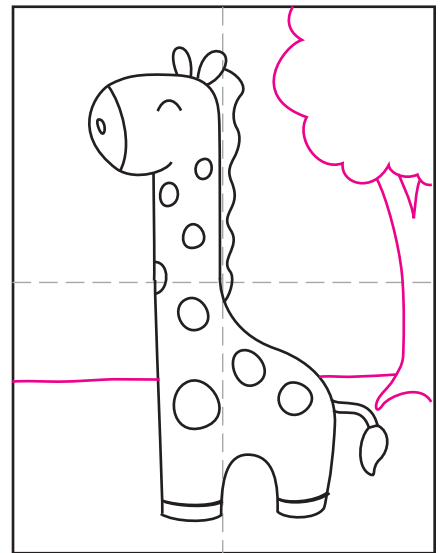

8. Finish with tree and horizon line.



A Guy

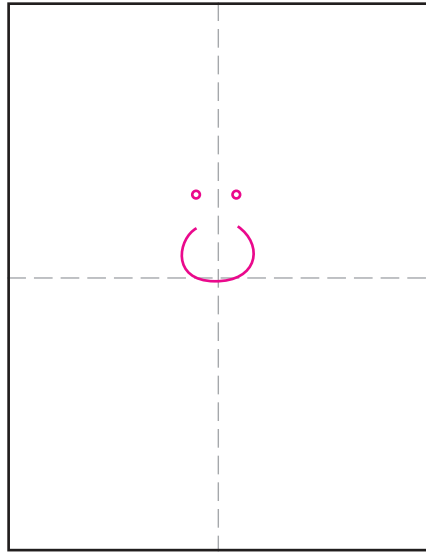

1. Make guide lines. Draw eyes, nose.

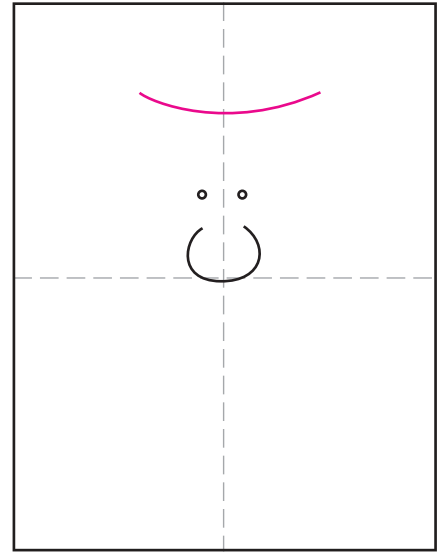

2. Draw hair curve.

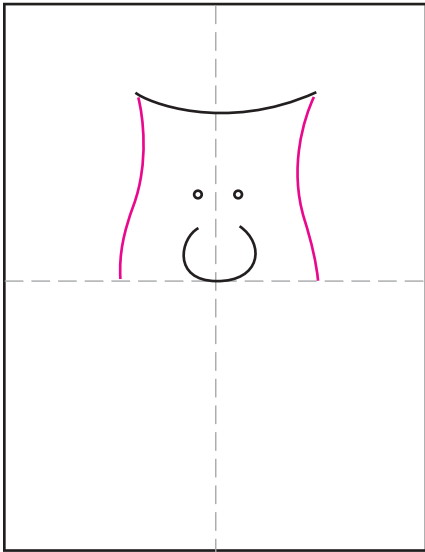

3. Add sides of face.

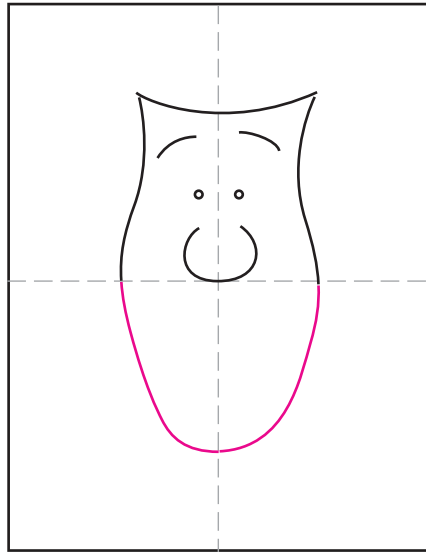

4. Draw bottom of face.

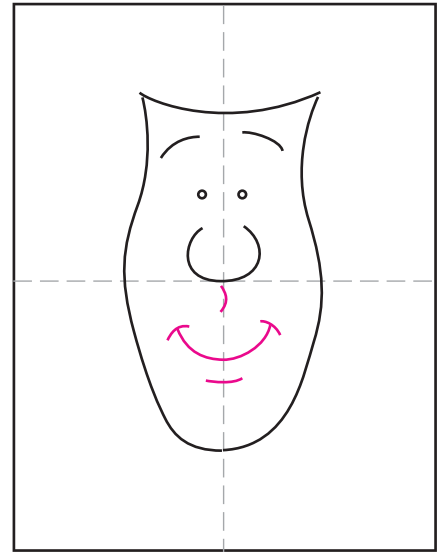

5. Add mouth and details.

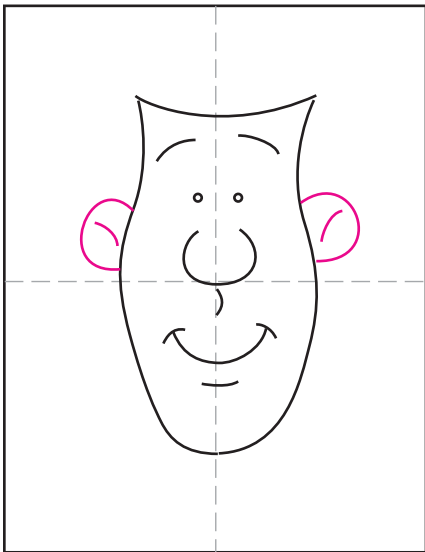

6. Draw two ears.

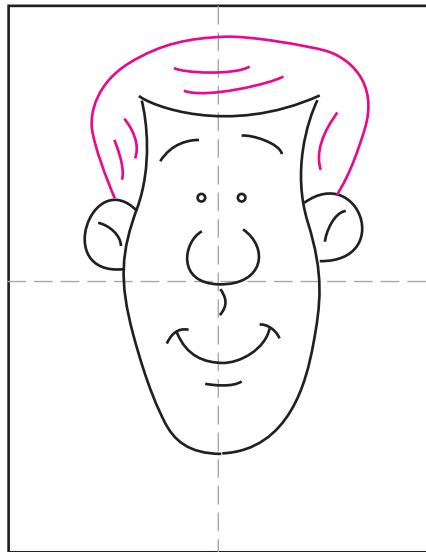

7. Add hair and hair lines.

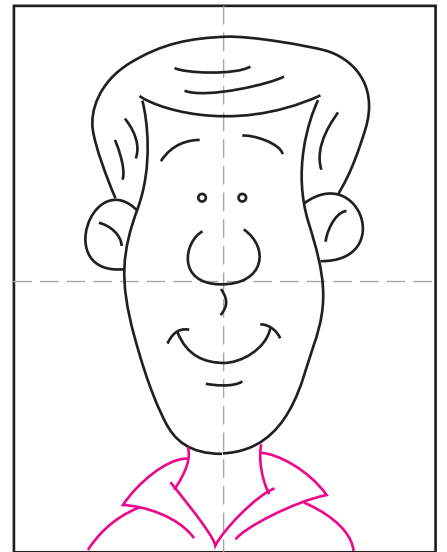

8. Draw neck and shirt.



Hamster

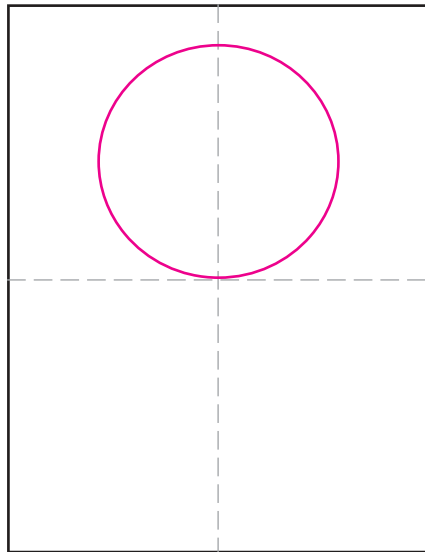

1. Make fold lines. Draw circle.

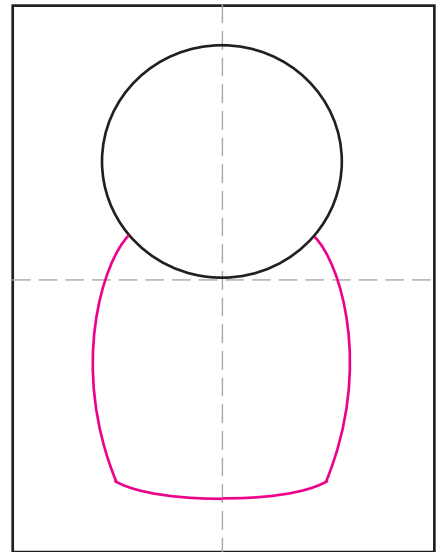

2. Add body shape shown below.

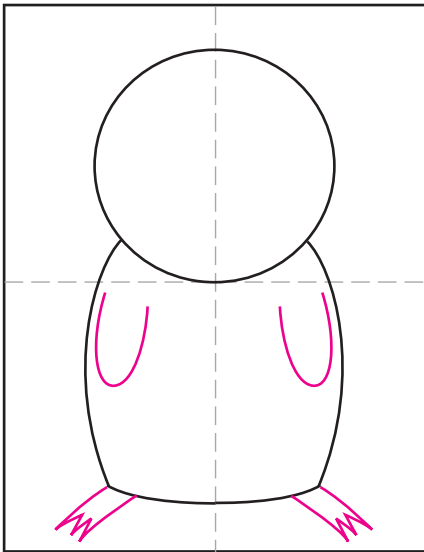

3. Add arms and feet.

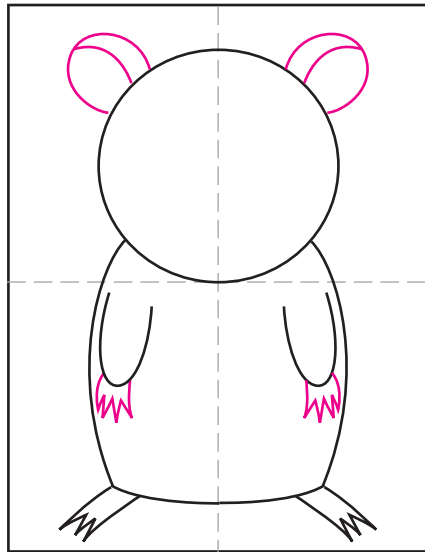

4. Add fingers and ears.

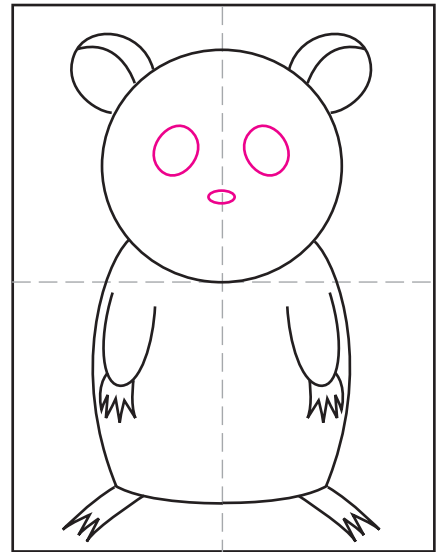

5. Draw the outside eye and nose.

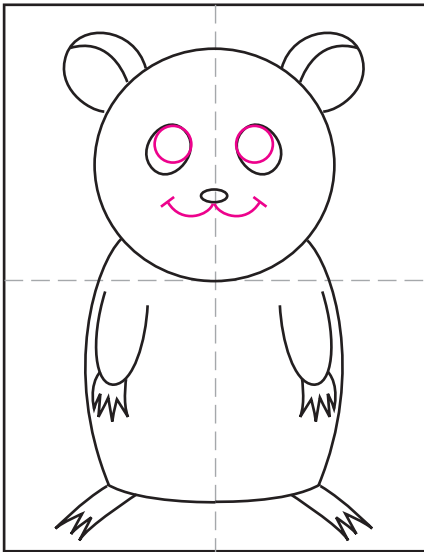

6. Add the inside eye and mouth.

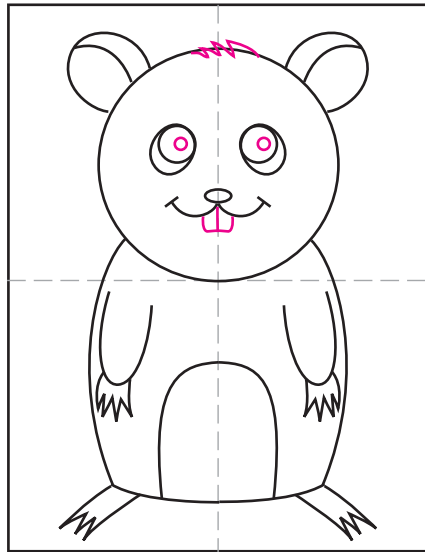

7. Add teeth, eye spots and hair.

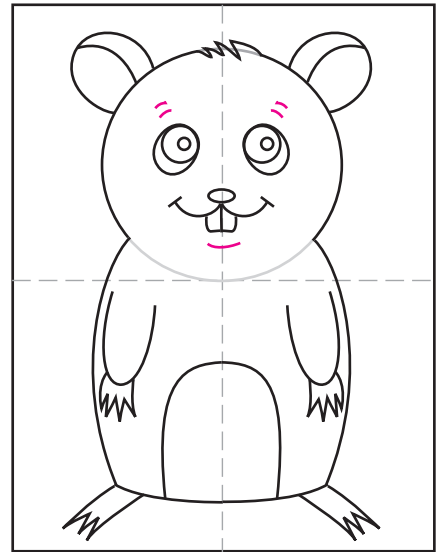

8. Add details and erase neck line.



Kimono Girl

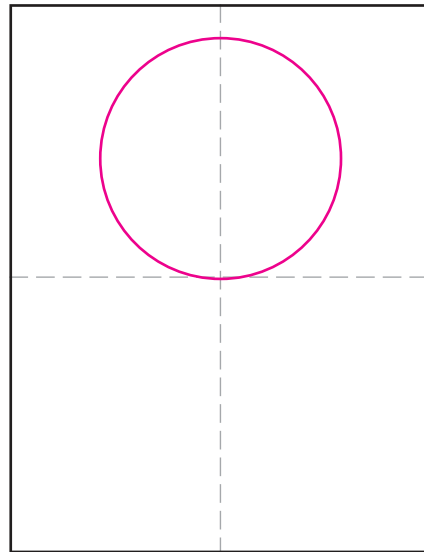

1. Make guide lines. Draw a circle.

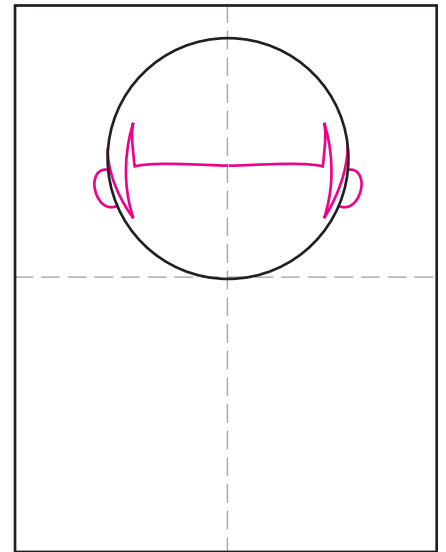

2. Add ears and hair line.

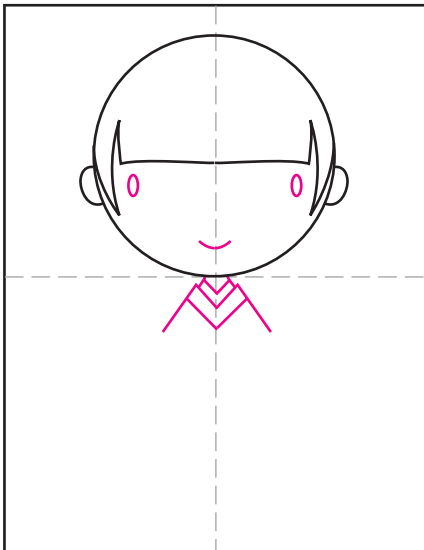

3. Draw eyes, mouth, collar.

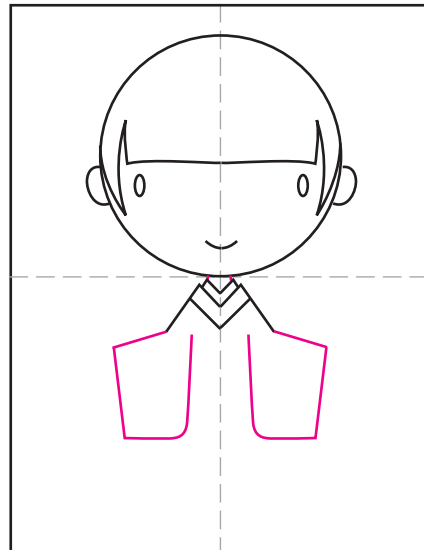

4. Complete kimono sleeves.

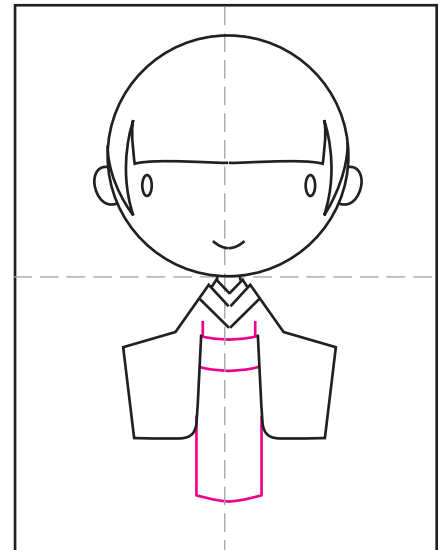

5. Draw kimono bottom and sash.

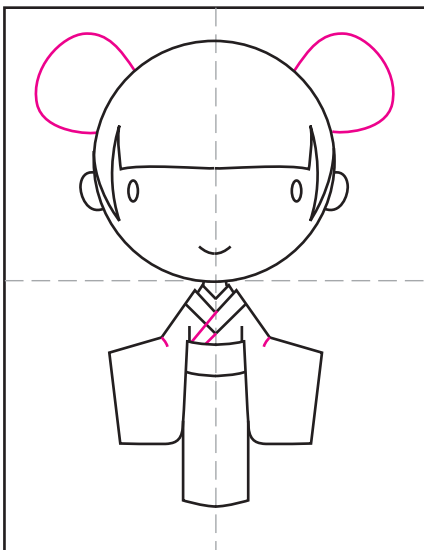

6. Draw kimono details, hair buns.

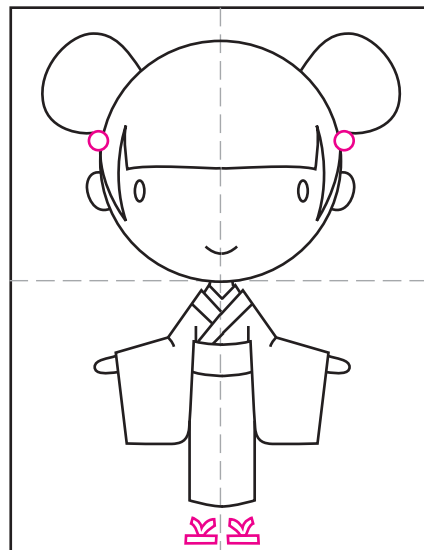

7. Start hair ties and draw sandals.

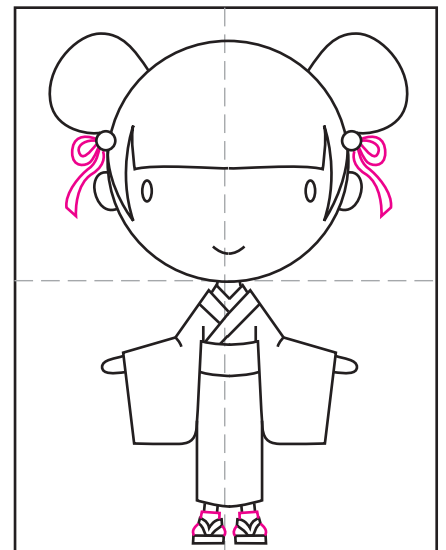

8. Finish hair ties and add socks.

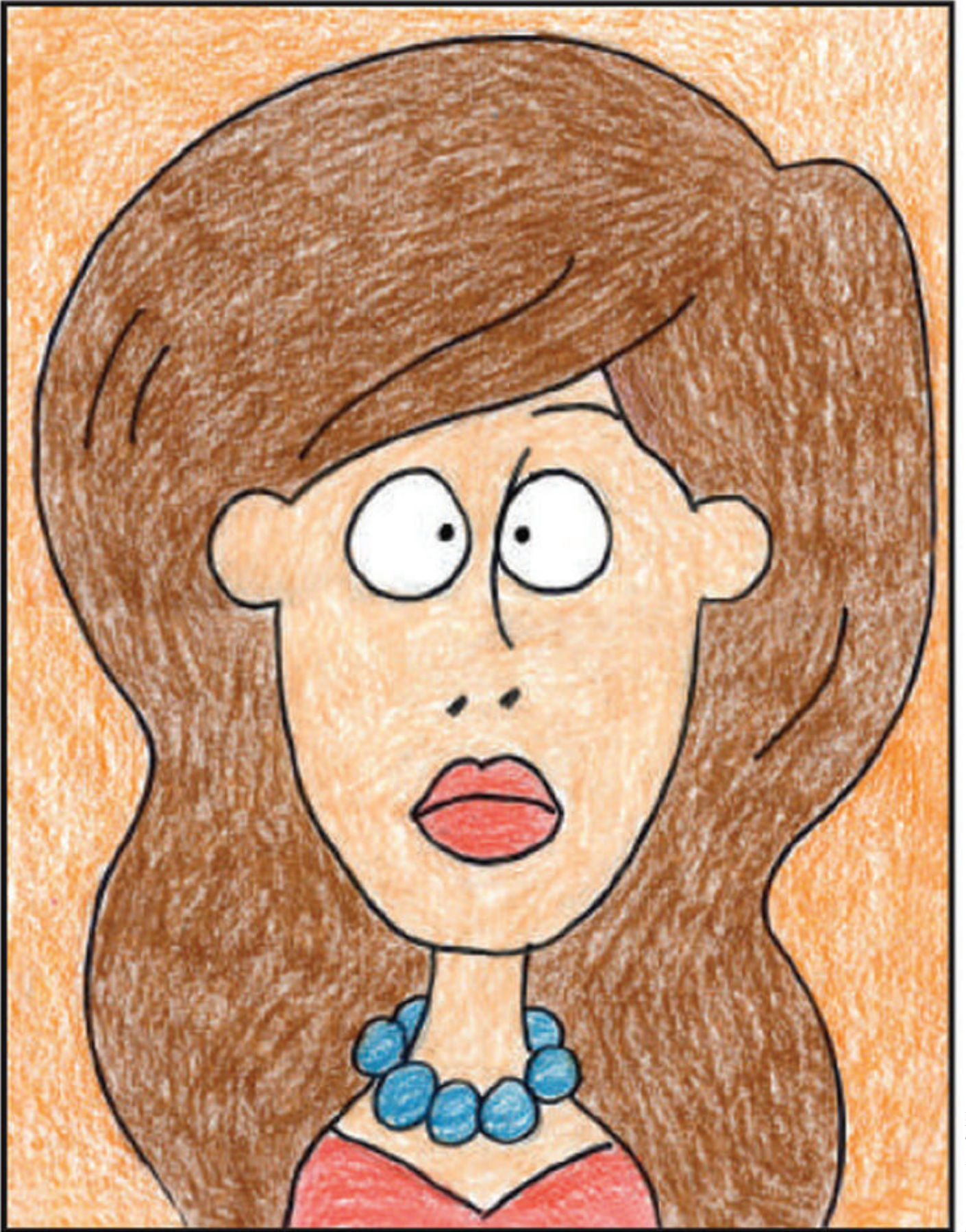

A Lady

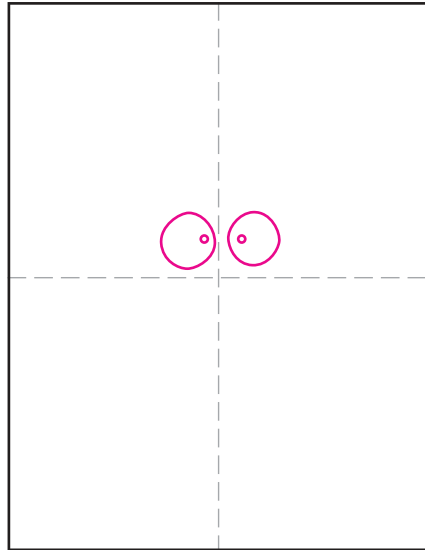
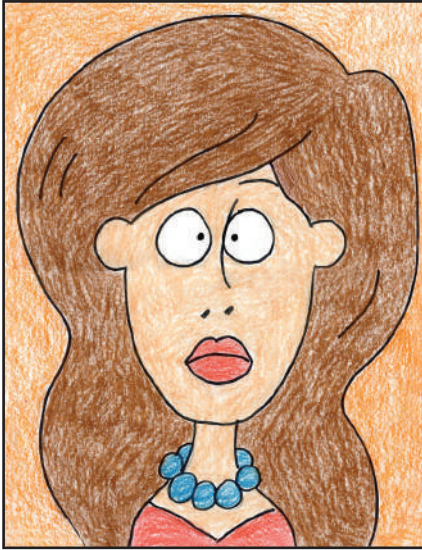

1. Make guide lines. Draw two eyes.

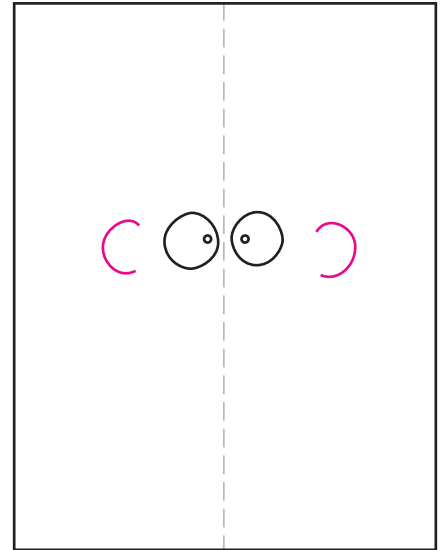

2. Draw two ears.

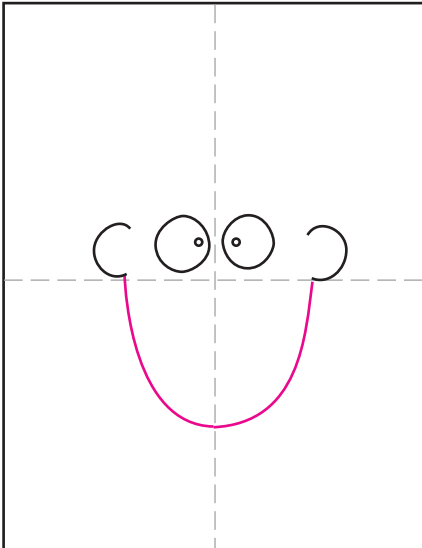

3. Draw bottom of face.

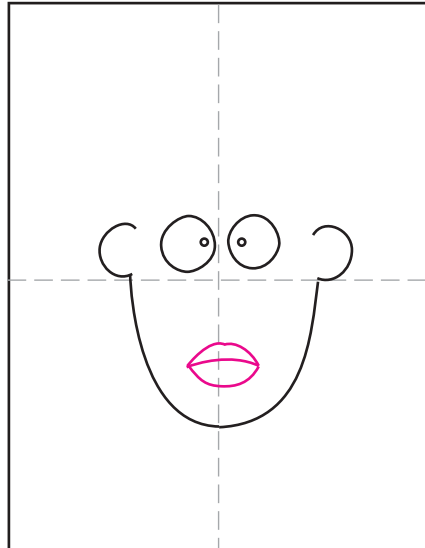

4. Add the mouth.

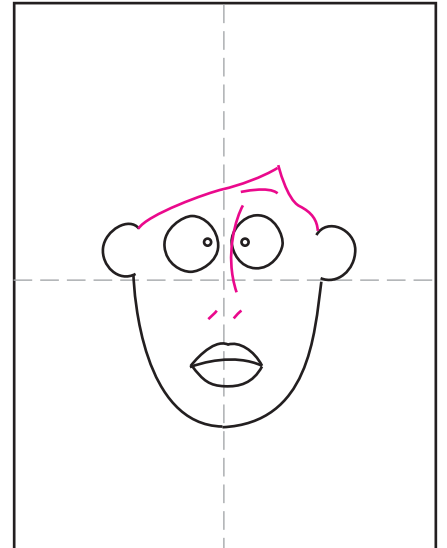

5. Draw hair line, nose, eyebrow.

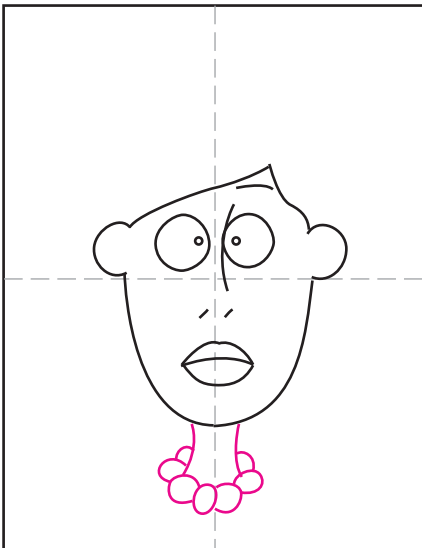

6. Draw neck and necklace.

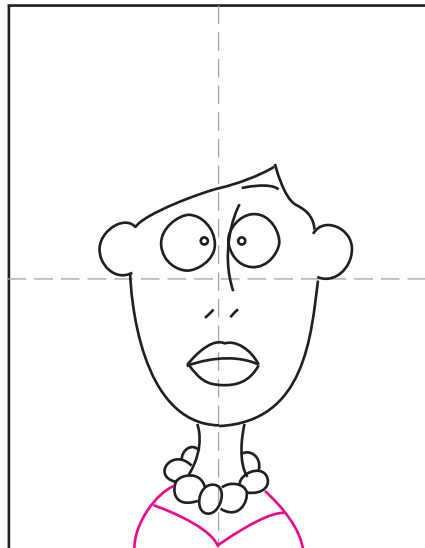

7. Add shoulders and dress line.

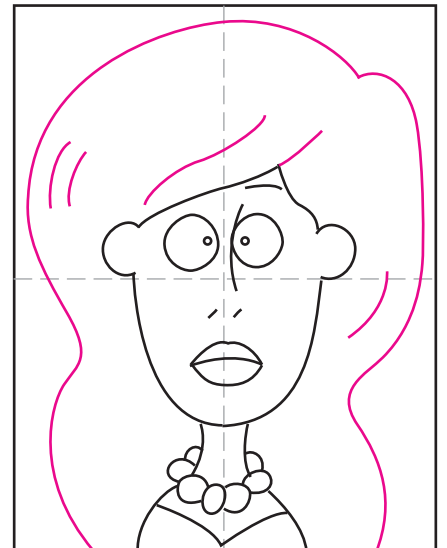

8. Draw big hair and hair lines.

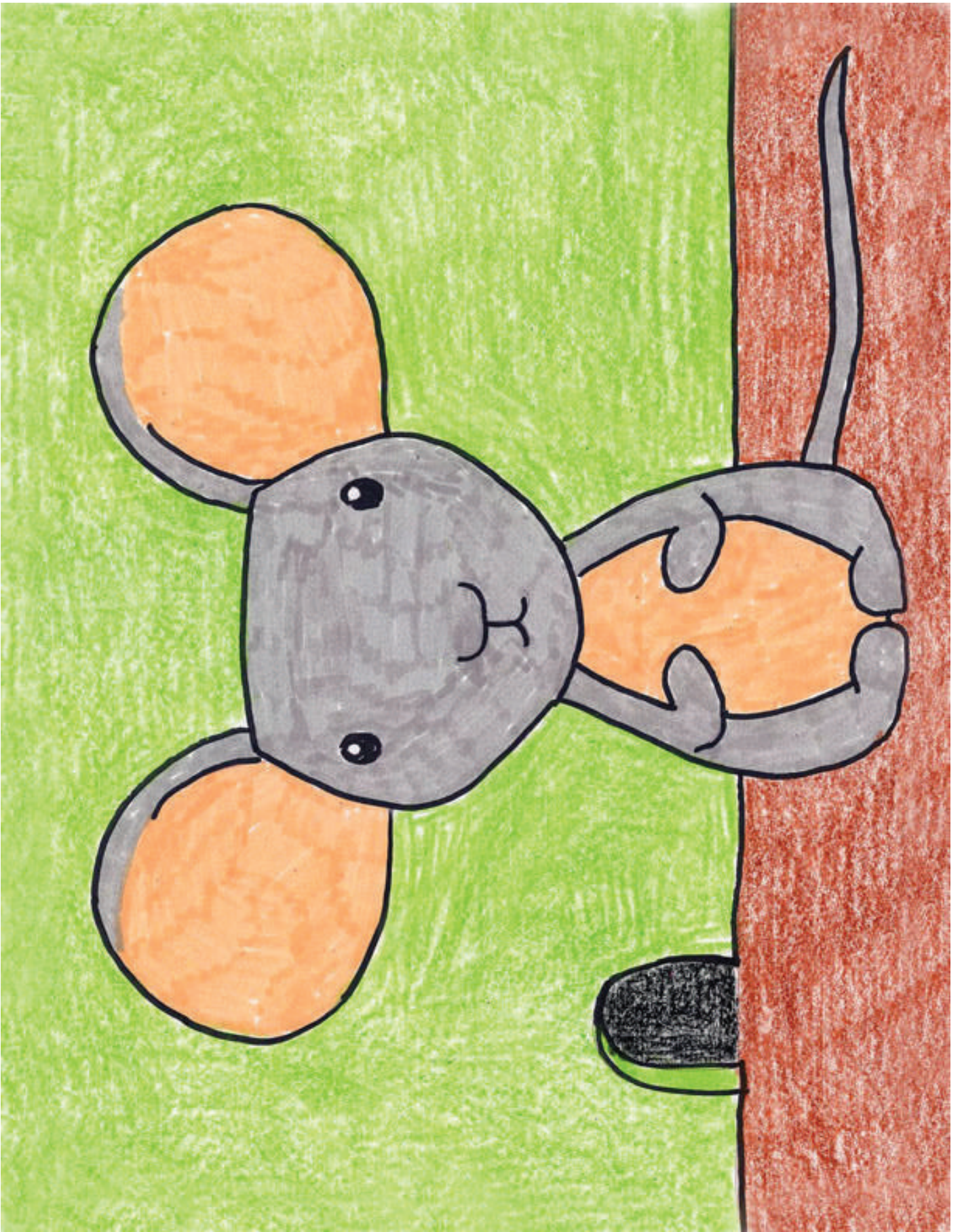

Mouse

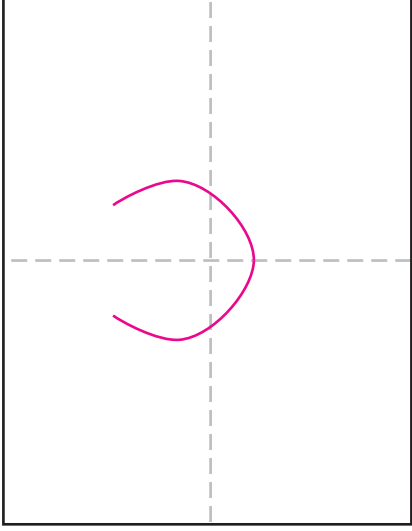
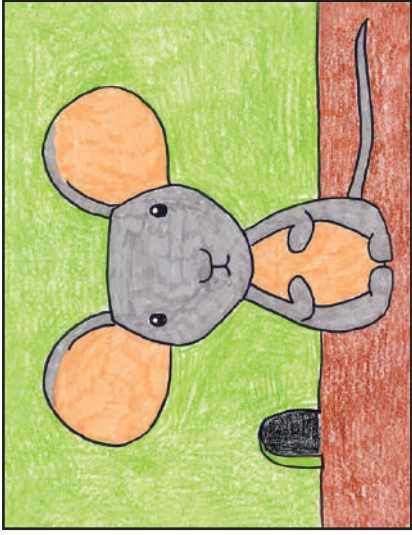

1. Make guide lines. Draw two circle tires.

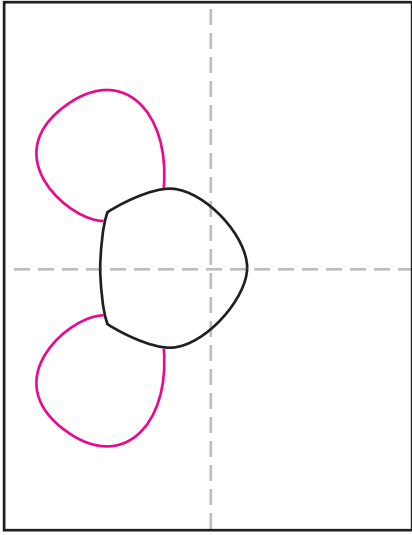

3. Finish the car body as shown.

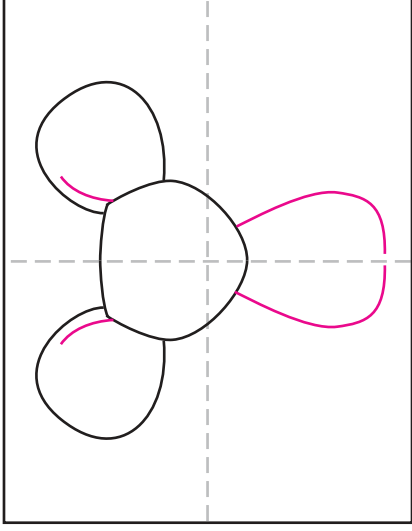

4. Draw the windshield and folded top.

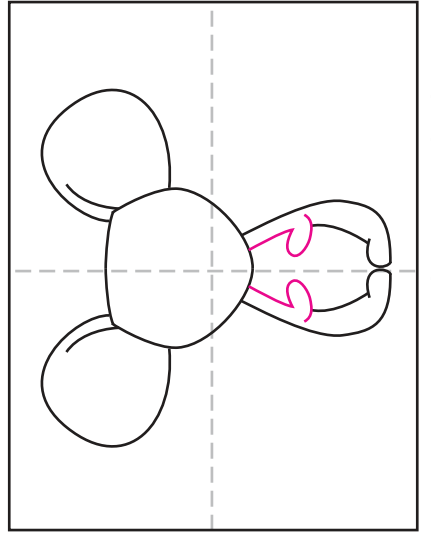

6. Draw a person and steering wheel.

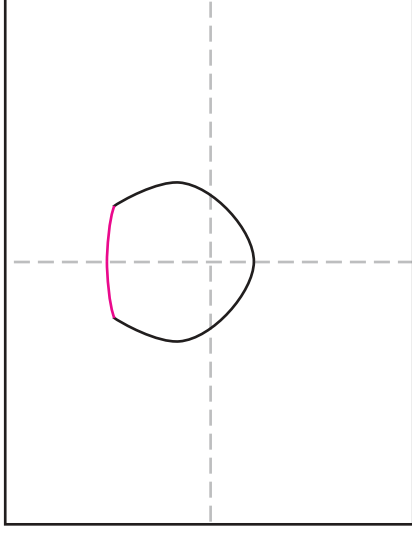

2. Add tire centers and two lines.

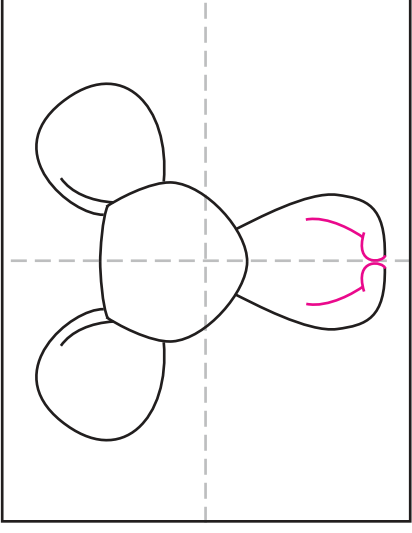

5. Add the car details as shown.

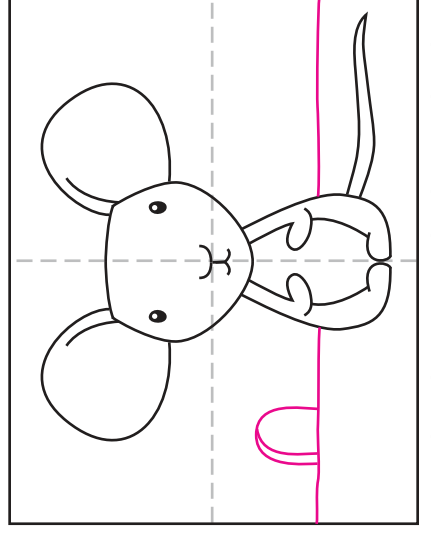

8. Finish with mountain background and sun.

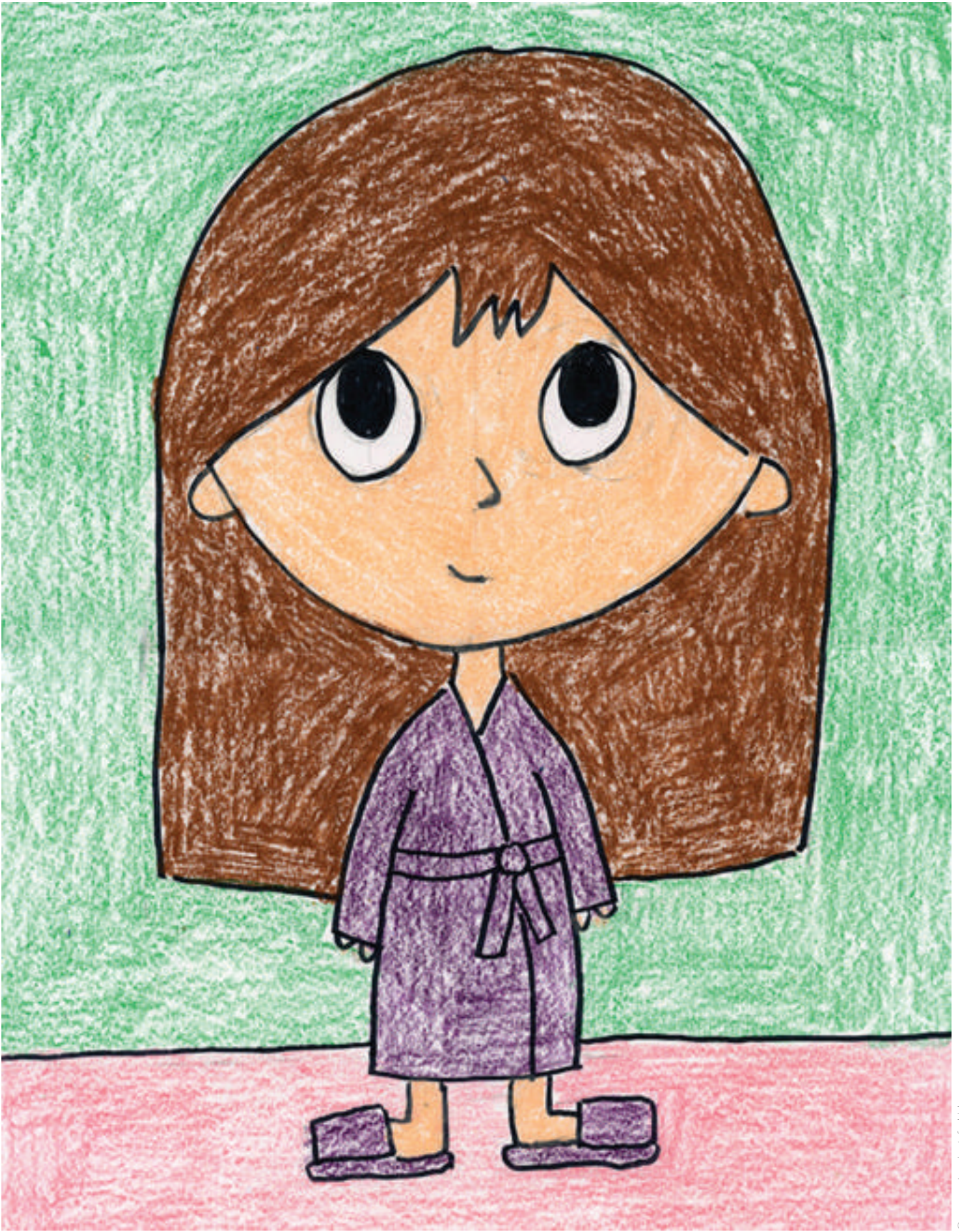

Pajama Girl

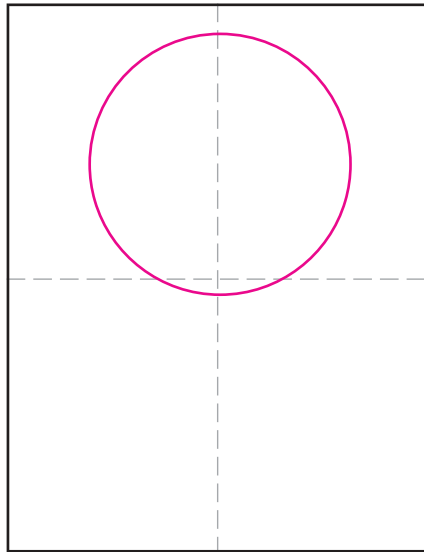
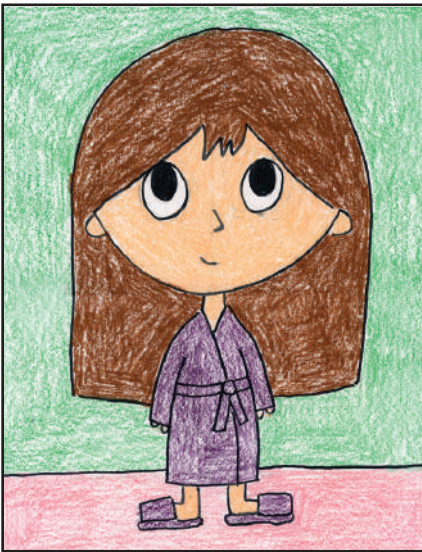

1. Make guide lines. Draw circle.

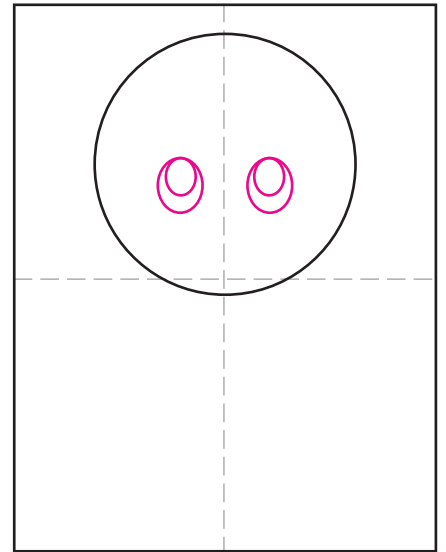

2. Draw eyes made of ovals.

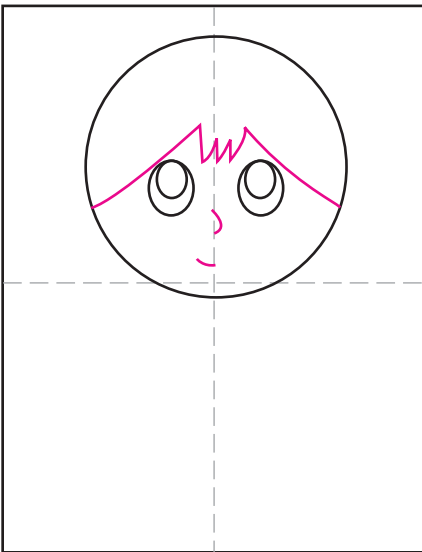

3. Add hair, nose and mouth.

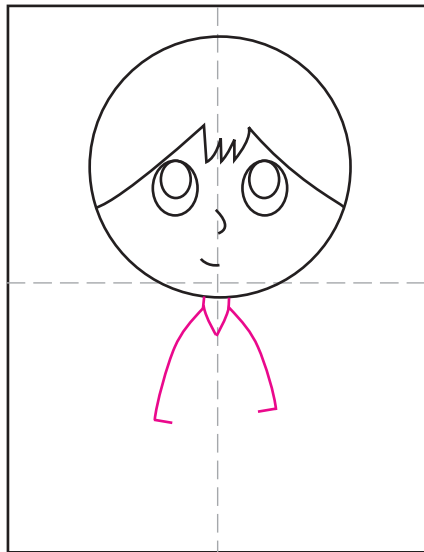

4. Draw neck and shoulders.

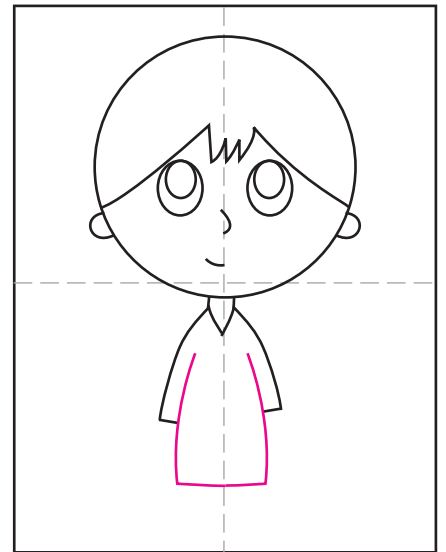

5. Finish the robe.

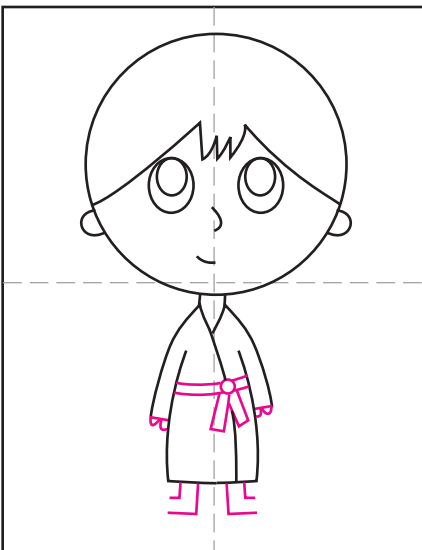

6. Draw robe details and feet.

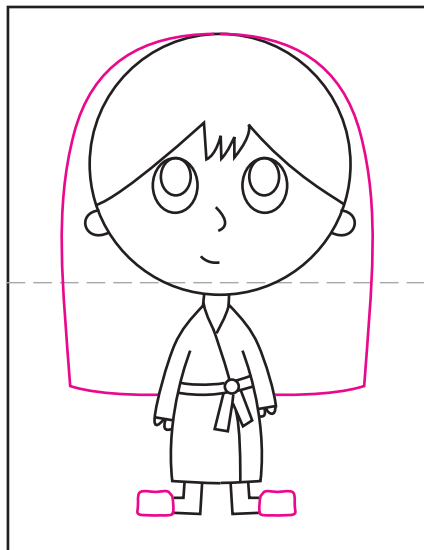

7. Start slippers. Add long hair.

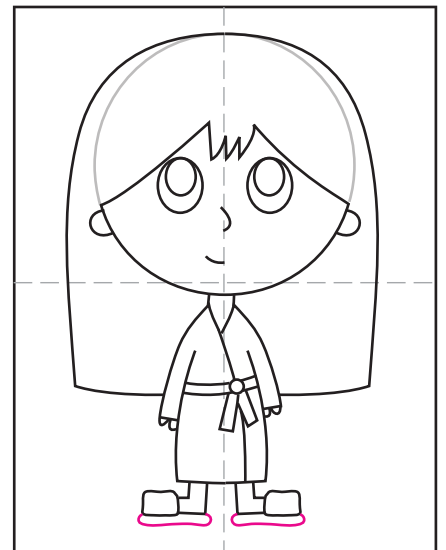

8. Finish slippers, erase gray line.



Panda

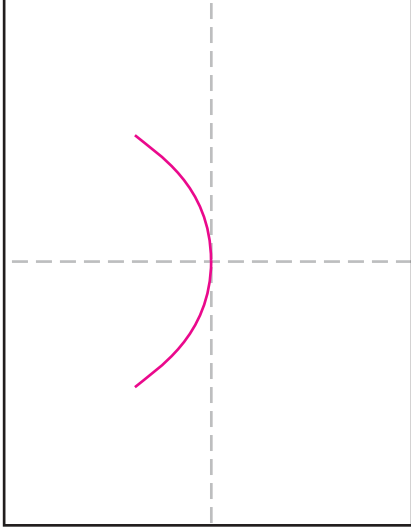

1. Make guide lines. Draw the chin.

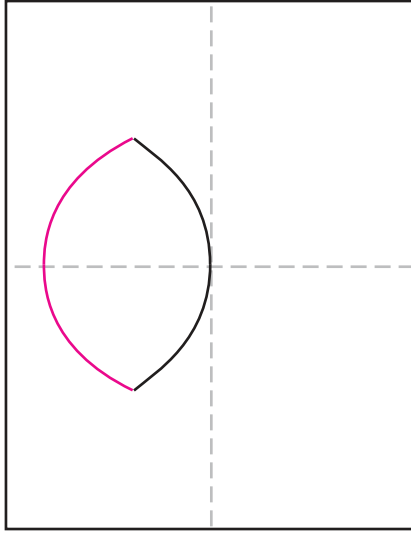

2. Finish the top of the head.

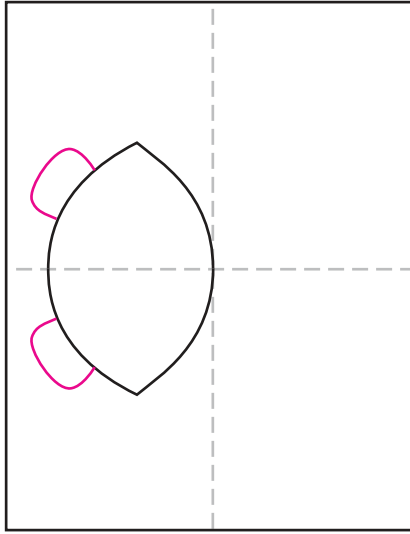

3. Add two ears.

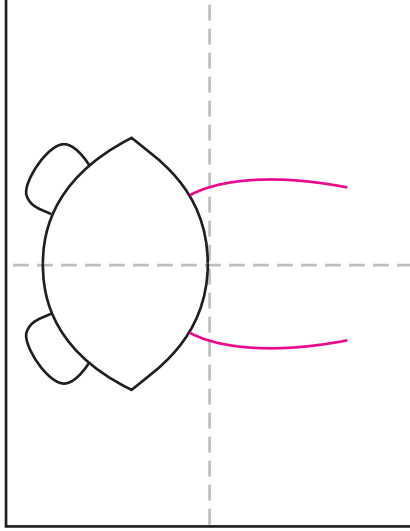

4. Start the arms.

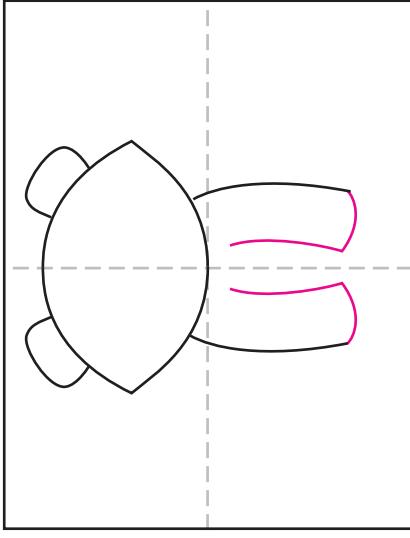

5. Finish the arms.

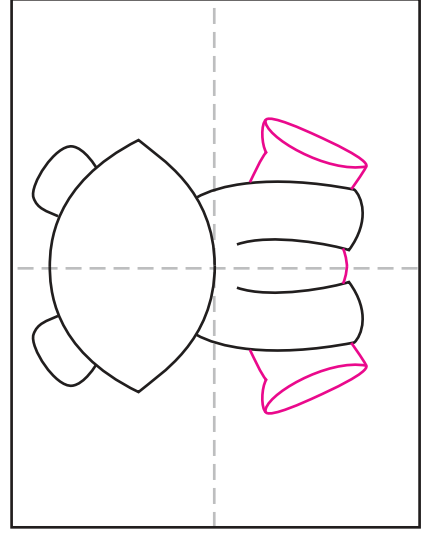

6. Add two legs and belly line.

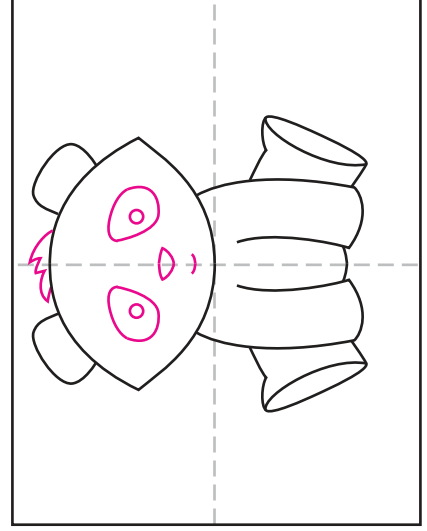

7. Draw the eyes, nose and mouth and fur.

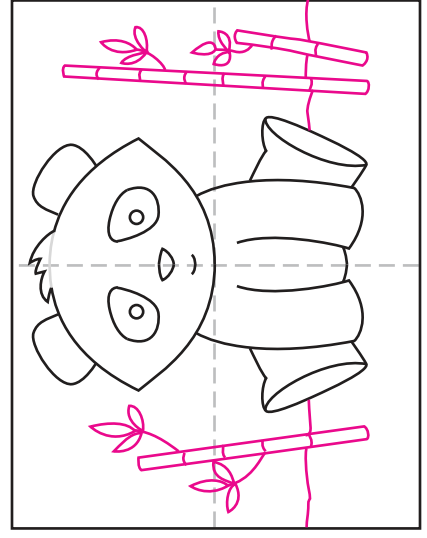

8. Finish with horizon line and bamboo trees.



Penguin

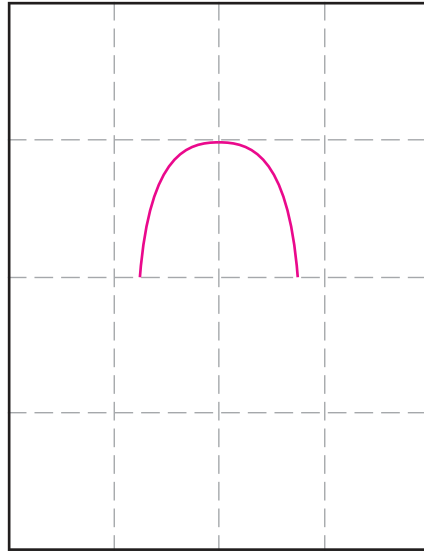

1. Make fold lines. Draw the head.

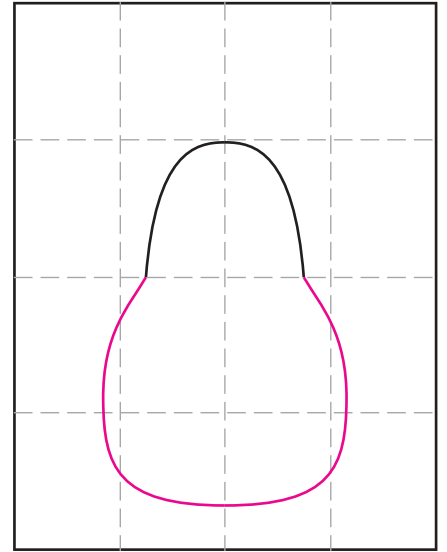

2. Draw the body.

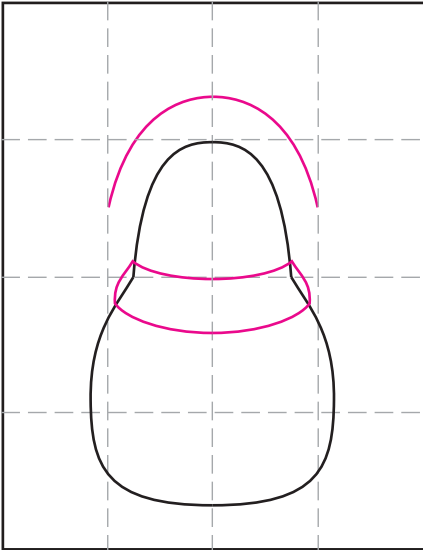

3. Add scarf and edge of hat.

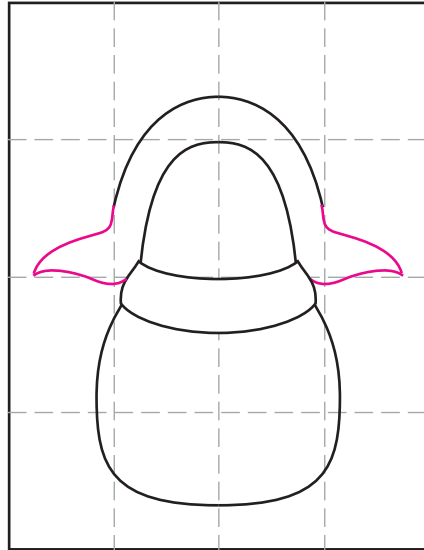

4. Finish ends of hat.

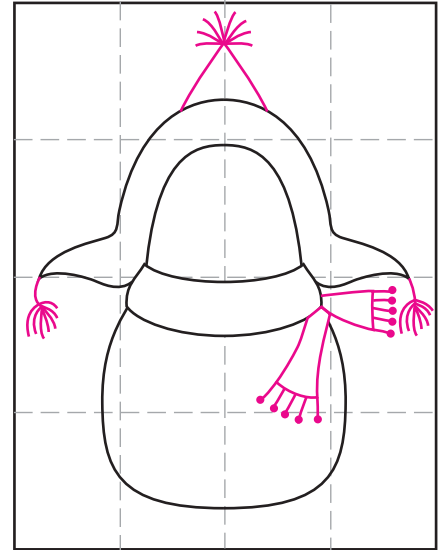

5. Finish hat and scarf ends.

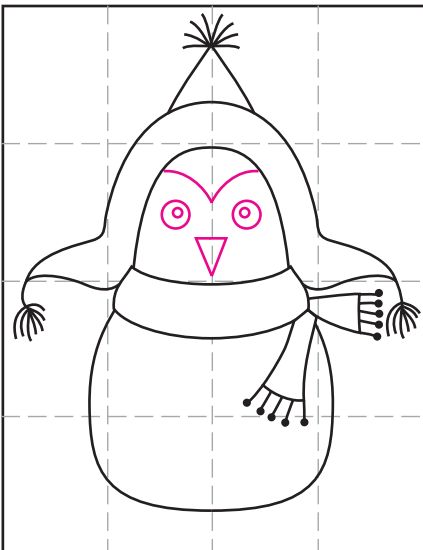

6. Draw the face.

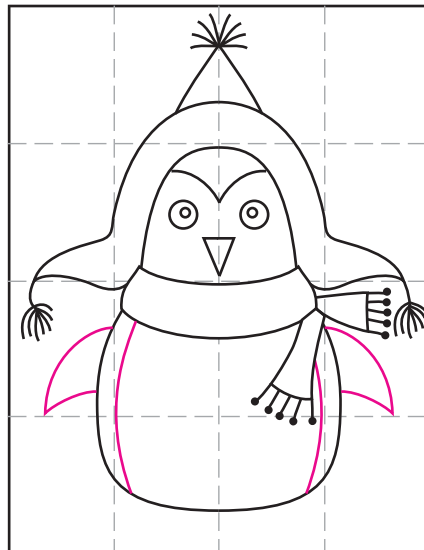

7. Add body lines and wings.

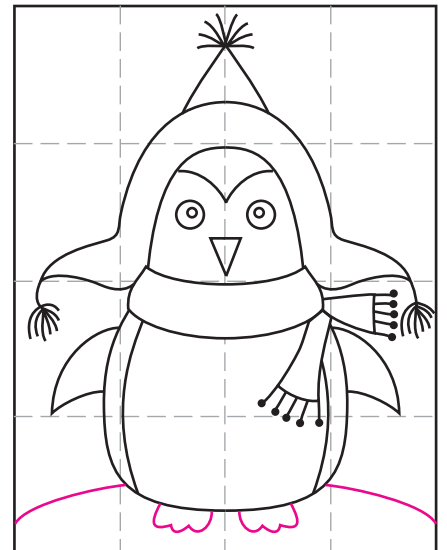

8. Draw the feet and ground.



Pigtail Girl

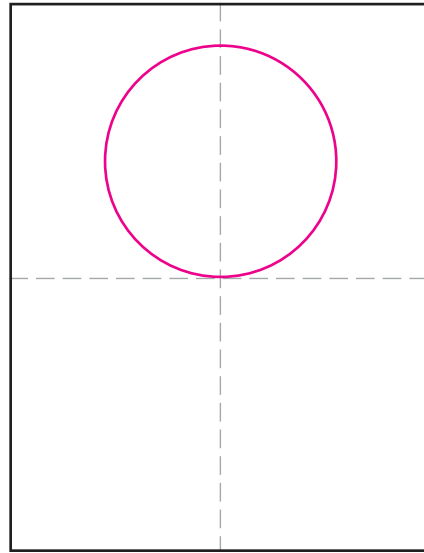

1. Make guide lines. Start the dress.

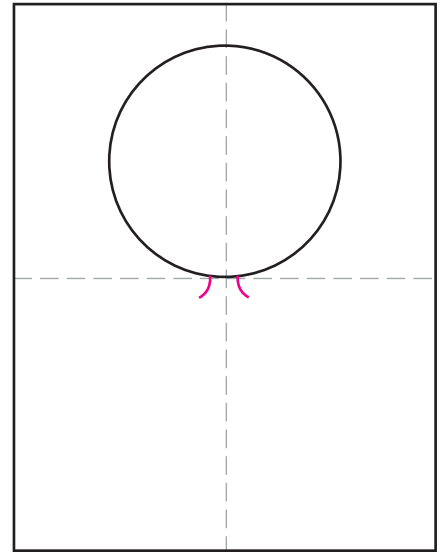

2. Add the dress skirt lines.

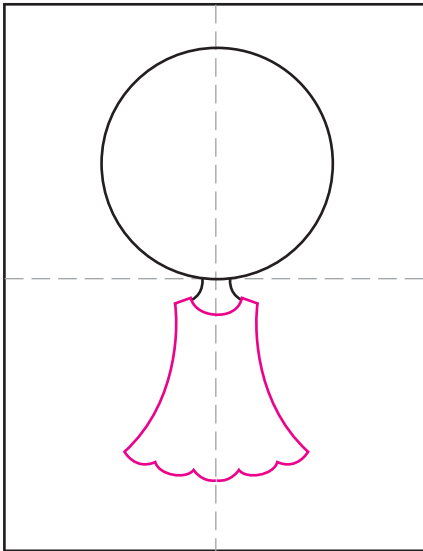

3. Add five evenly spaced lines.

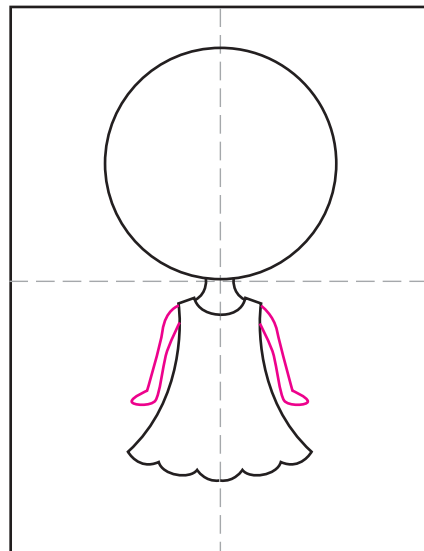

4. Draw the scalloped dress hem.

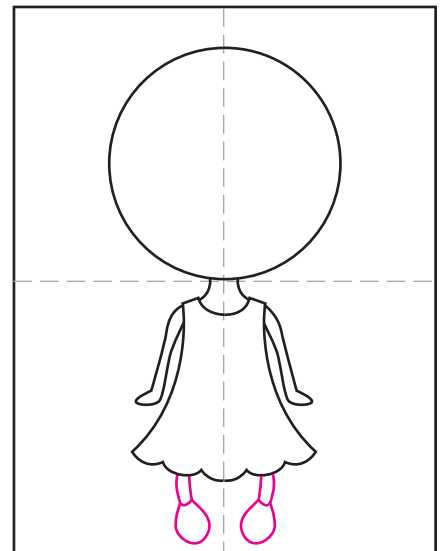

5. Draw the arms.

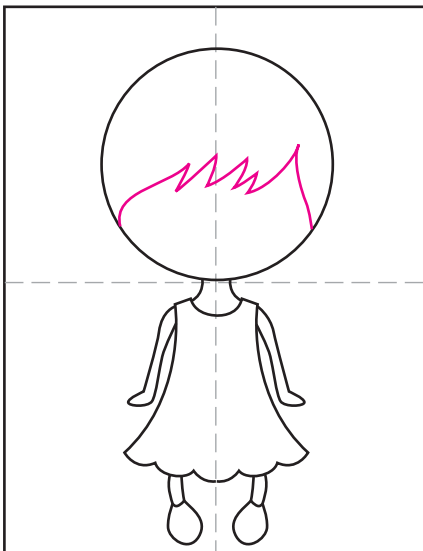

6. Draw the head.

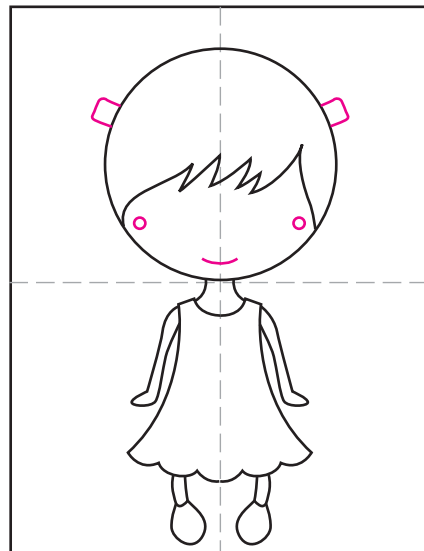

7. Add face and hair.

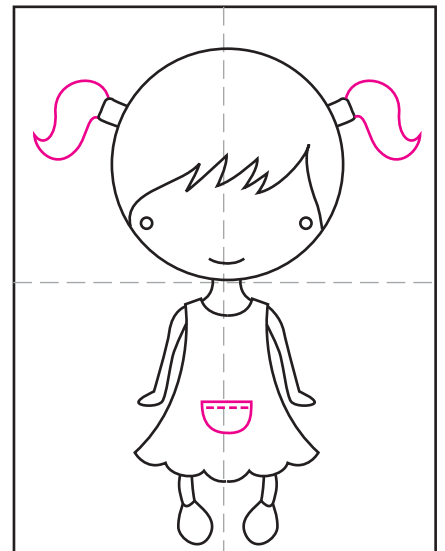

8. Finish with feet and crown.



Princess

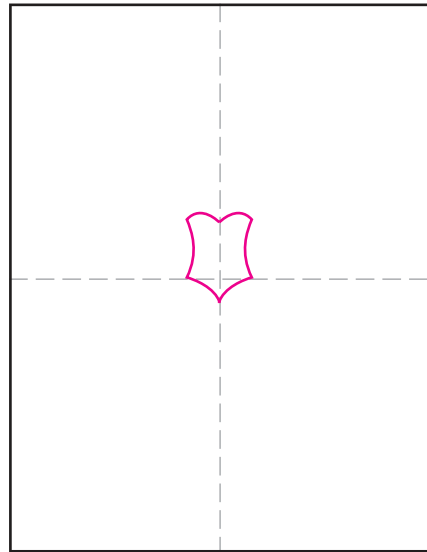

1. Make guide lines. Start the dress.

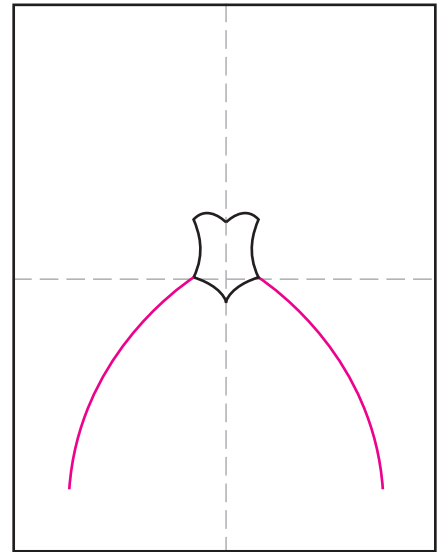

2. Add the dress skirt lines.

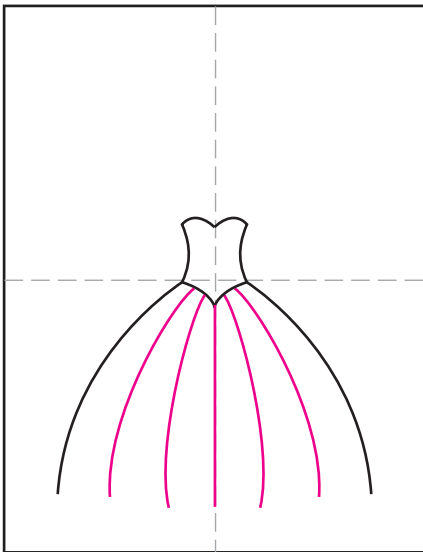

3. Add five evenly spaced lines.

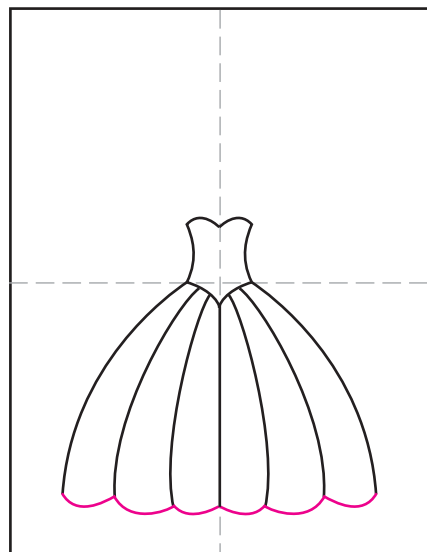

4. Draw the scalloped dress hem.

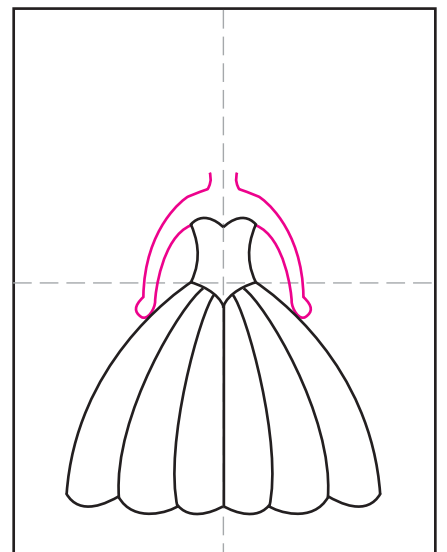

5. Draw the arms.

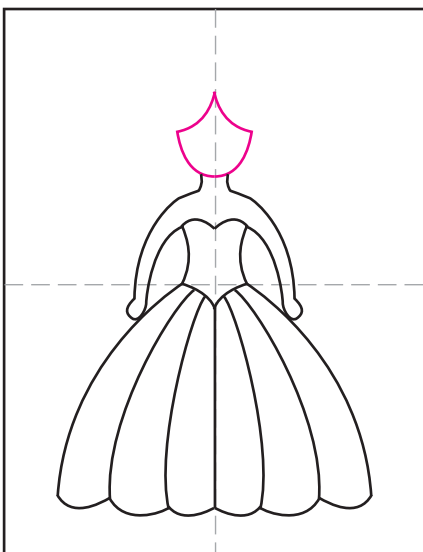

6. Draw the head.

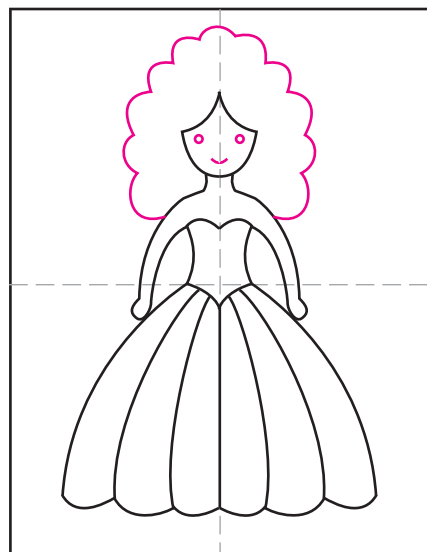

7. Add face and hair.

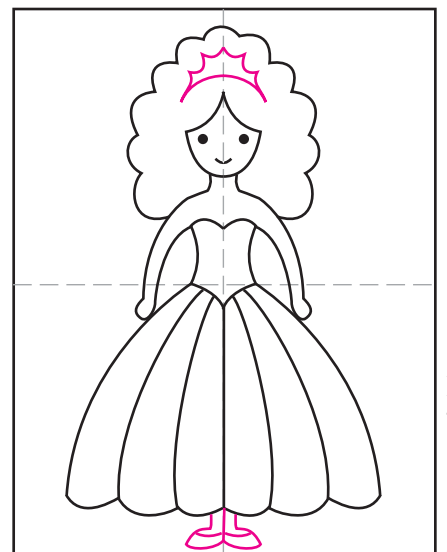

8. Finish with feet and crown.



Sheep



Supplies: Marker and crayons.

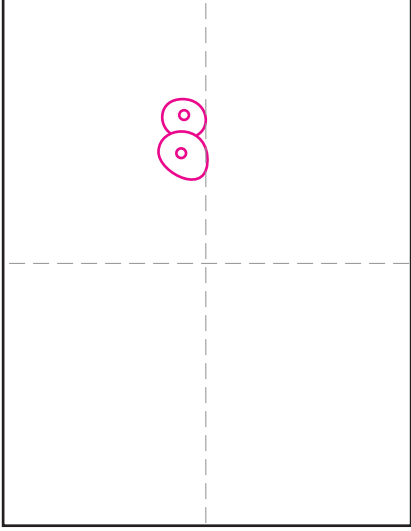

1. Make guide lines. Draw two eyes.

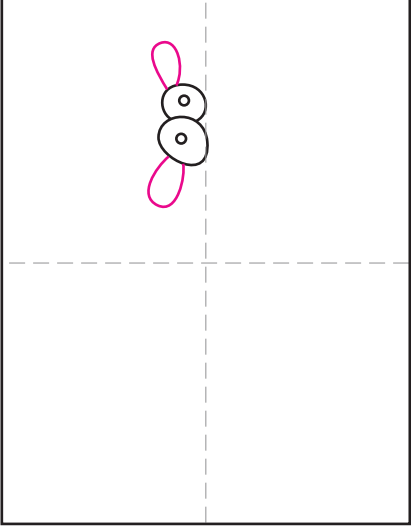

2. Add two ears.

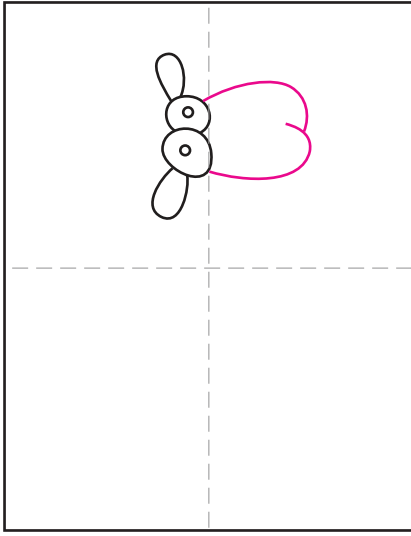

3. Draw curvy face as shown.

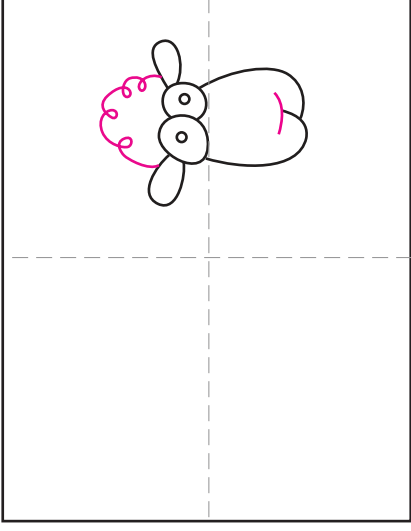

4. Add nose and curly head line.

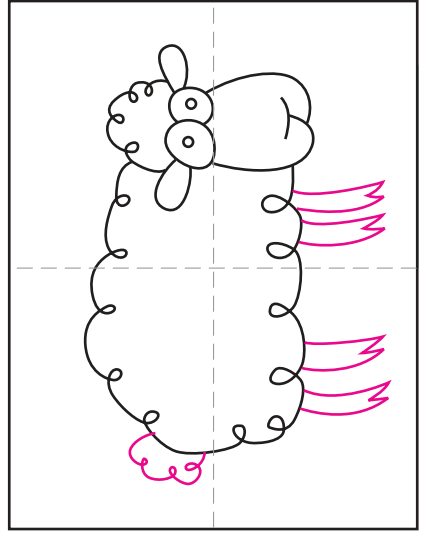

5. Draw four simple legs and tail.

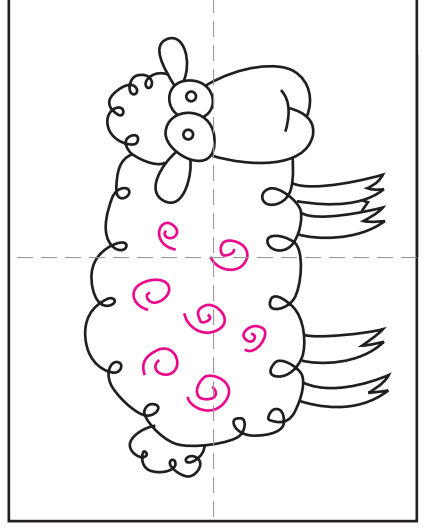

7. Add swirls inside body.

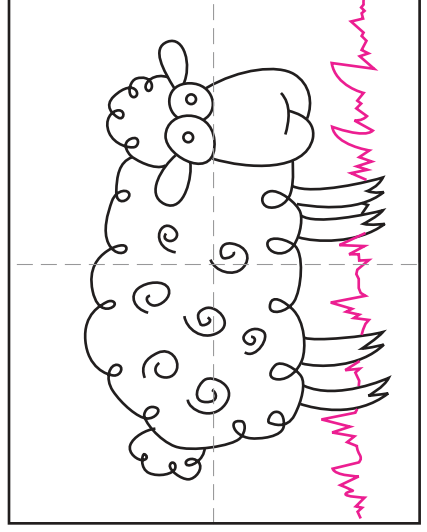

8. Draw grass lines in background.



A Smart Guy

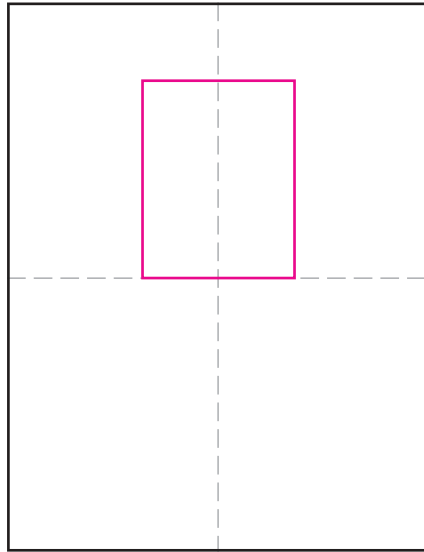

1. Make guide lines. Draw rectangle.

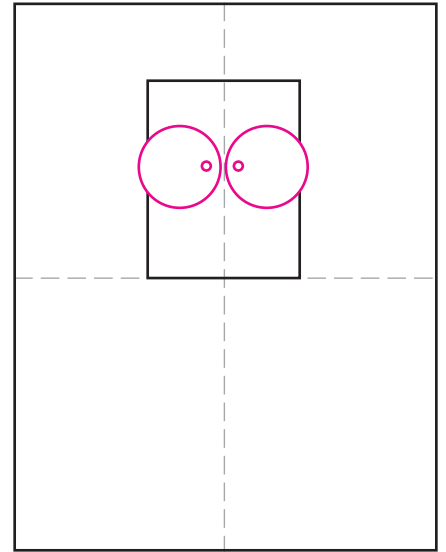

2. Draw two large circle eyes.

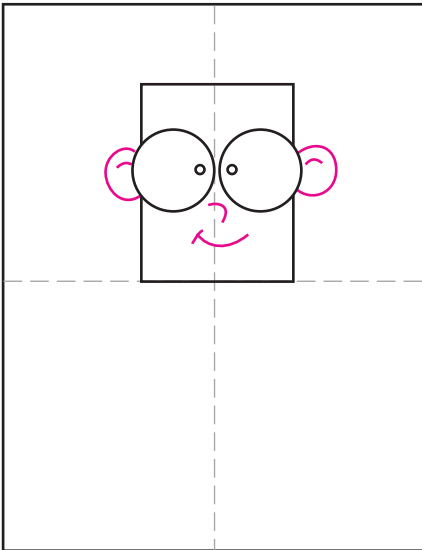

3. Add ears, nose and mouth.

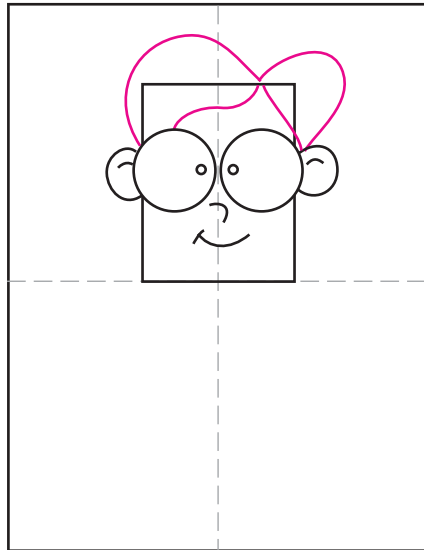

4. Draw outside of hair.

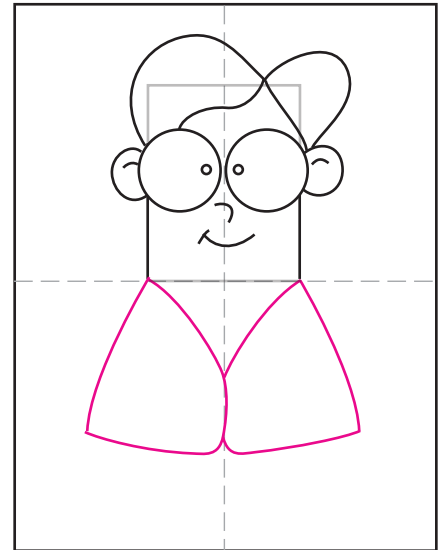

5. Erase gray lines. Draw suit.

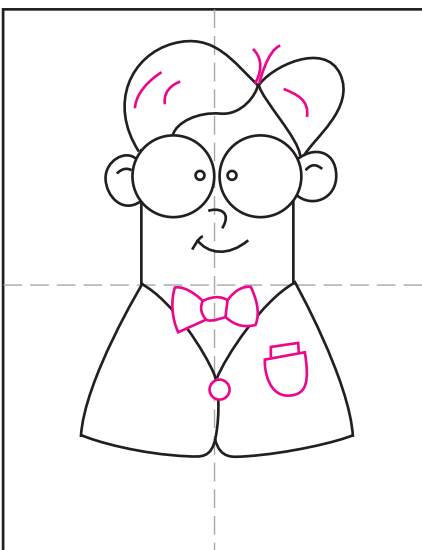

6. Draw tie, button, pocket, hair.

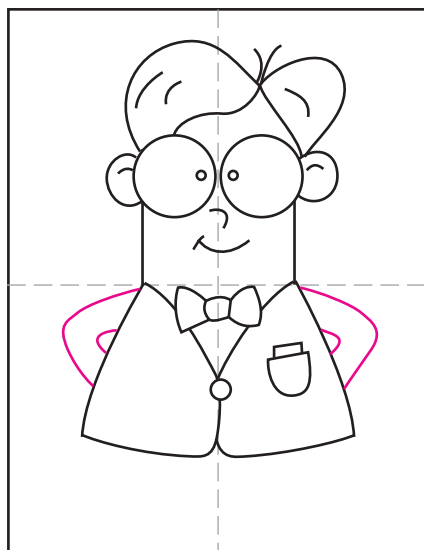

7. Add two arms.

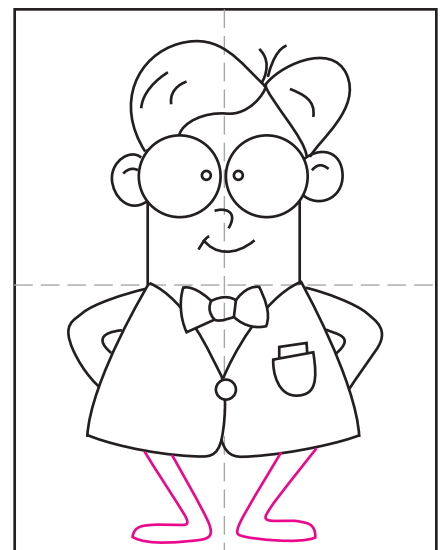

8. Draw two legs.



Sombrero Boy

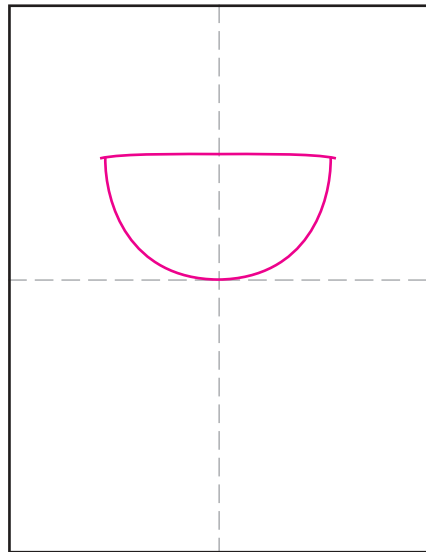
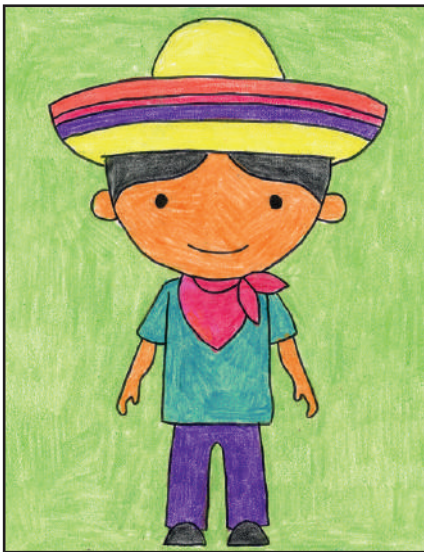

1. Make guide lines. Draw the head.

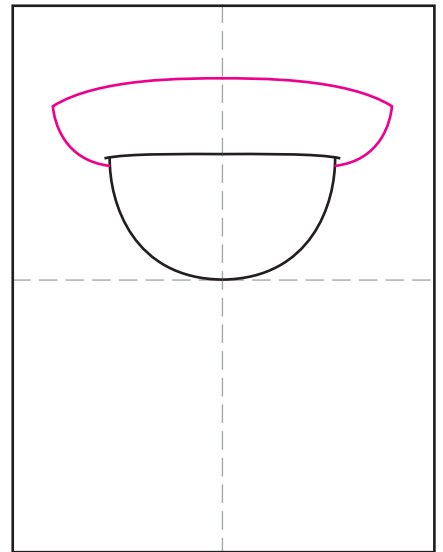

2. Add the brim of the hat.

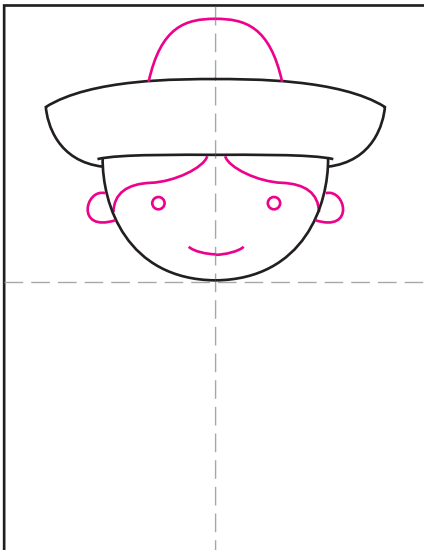

3. Add top hat and face details.

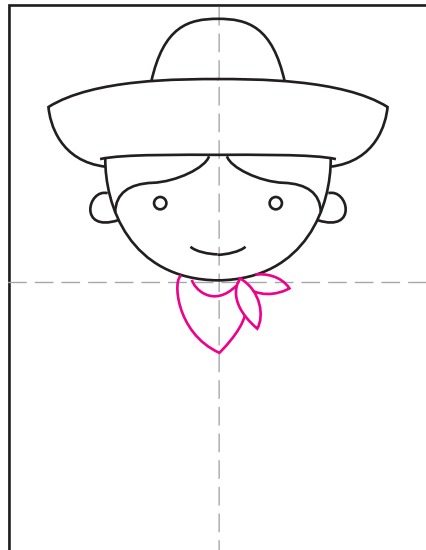

4. Draw scarf around neck.

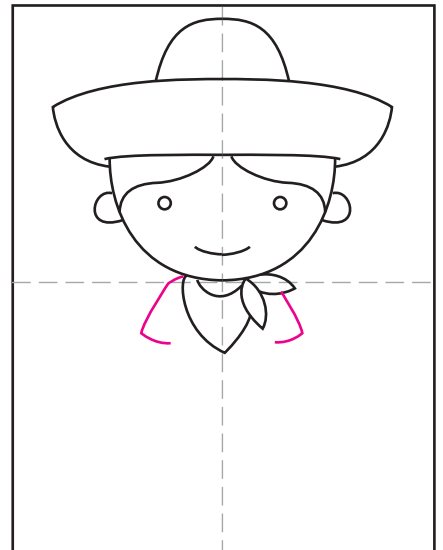

5. Draw the sleeves.

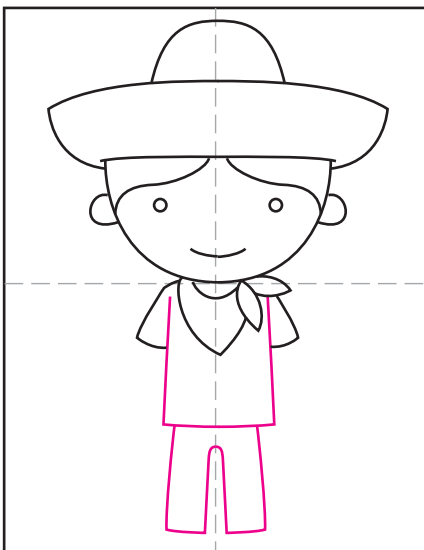

6. Finish the shirt, add the pants.

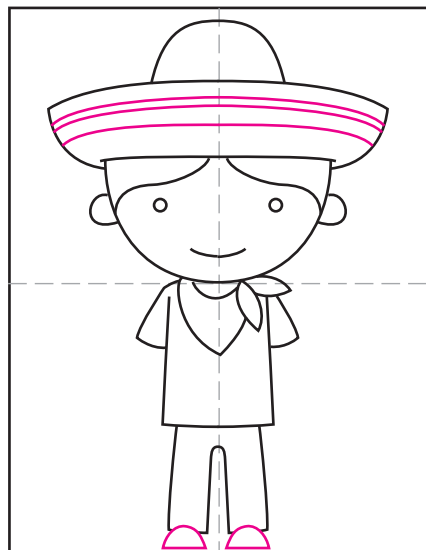

7. Draw the shoes and hat details.

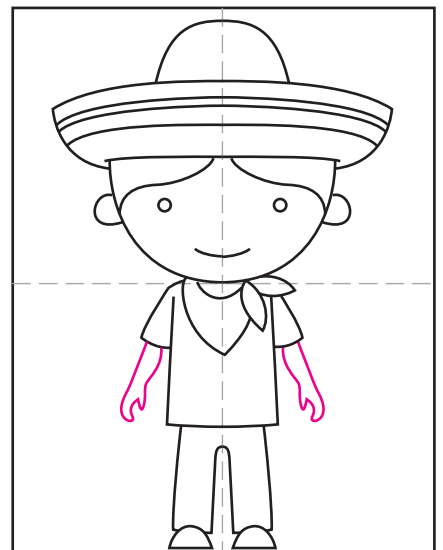

8. Add the arms.

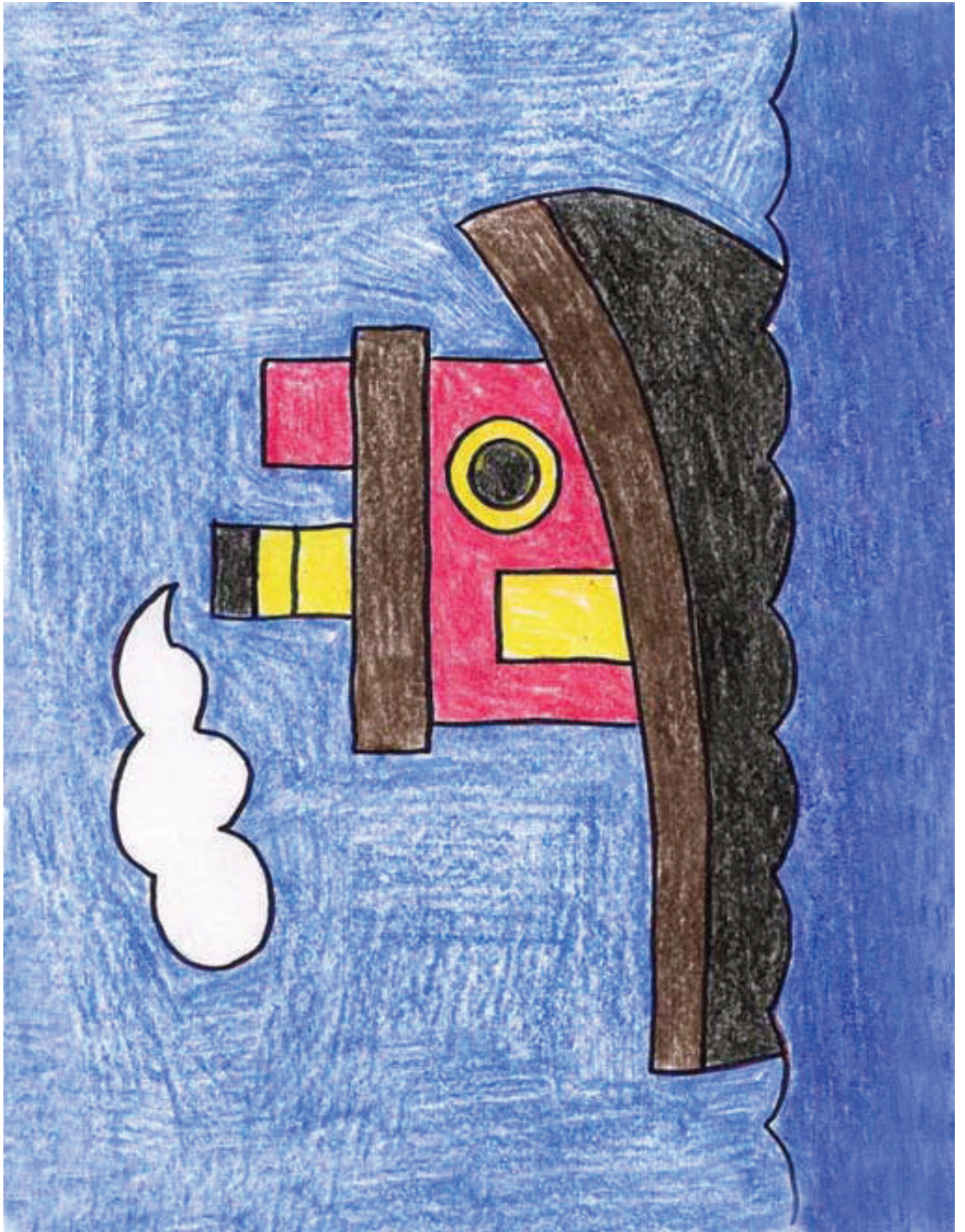

Tugboat

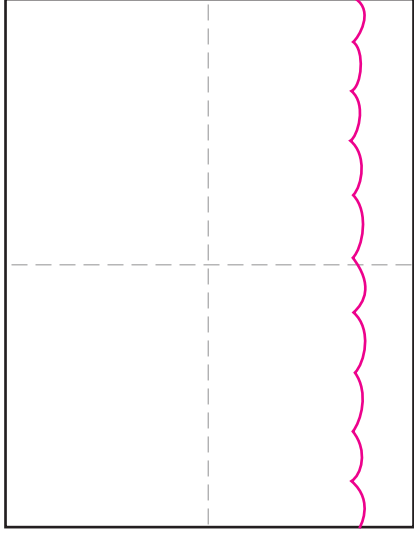
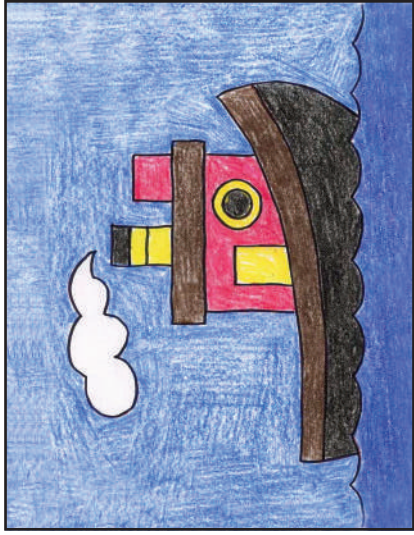

1. Make guide lines. Draw the waves.

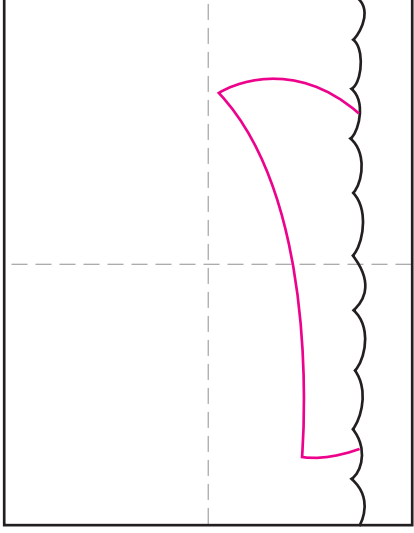

2. Draw the bottom boat.

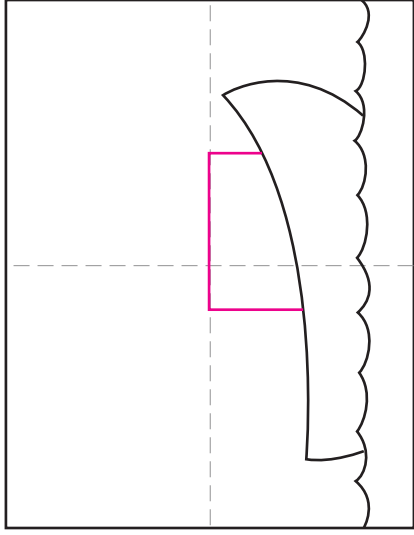

3. Add boat top.

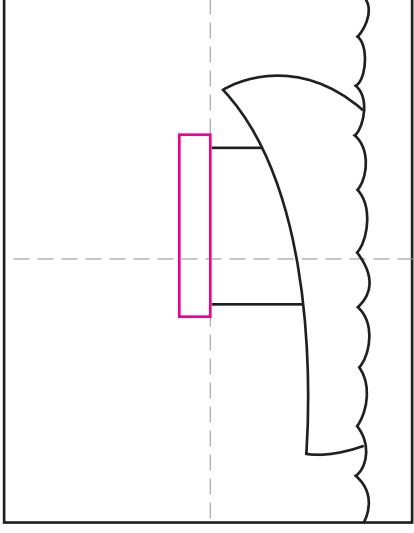

4. Draw roof of boat.

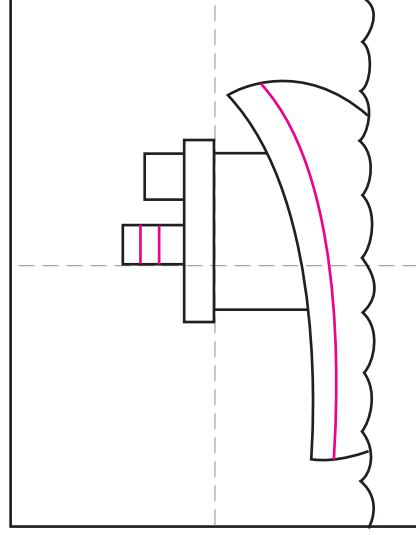

6. Add details to pipe and boat.

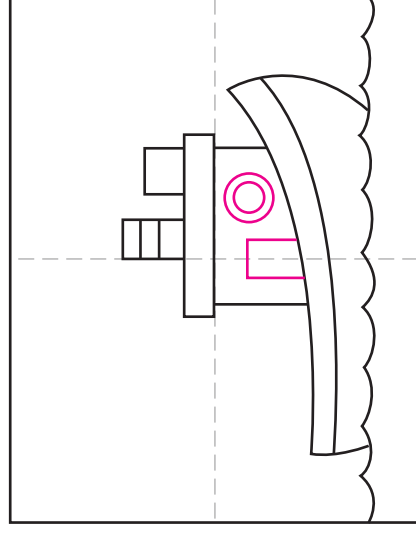

7. Add the door and window.

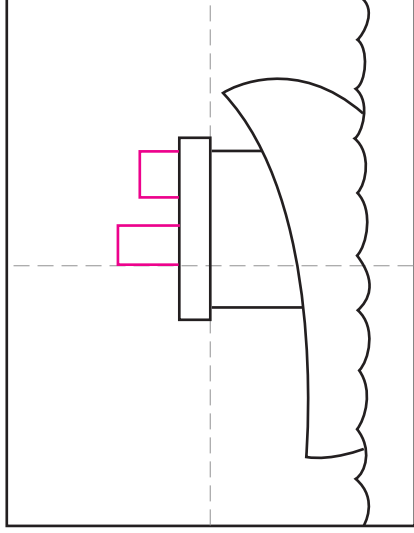

5. Add pipes on top of roof.

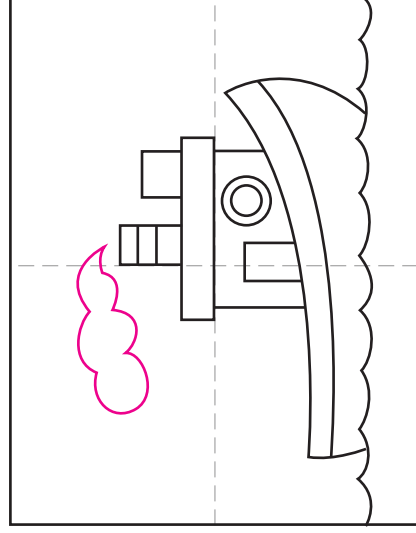

8. Draw smoke coming out of pipe.

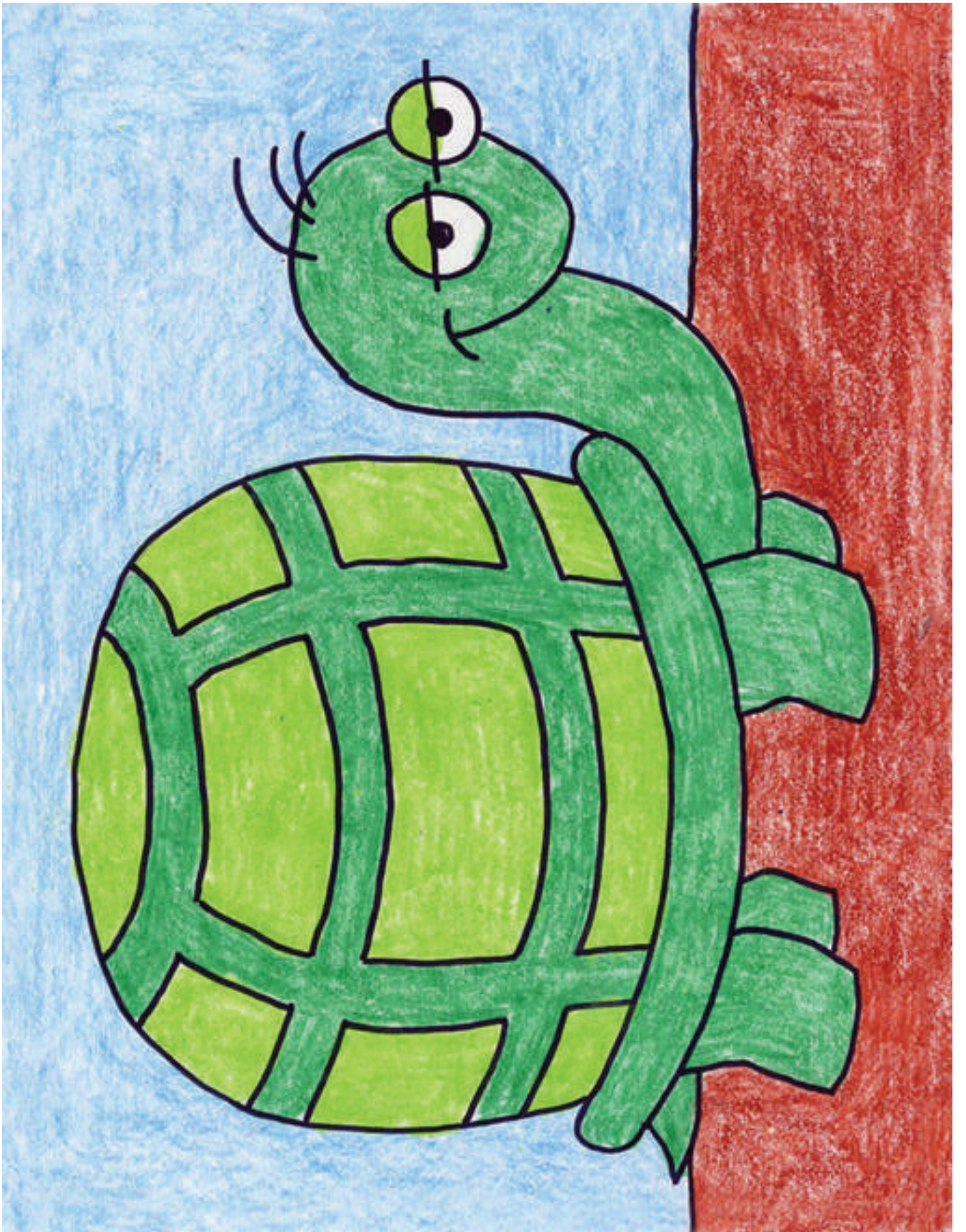

Turtle

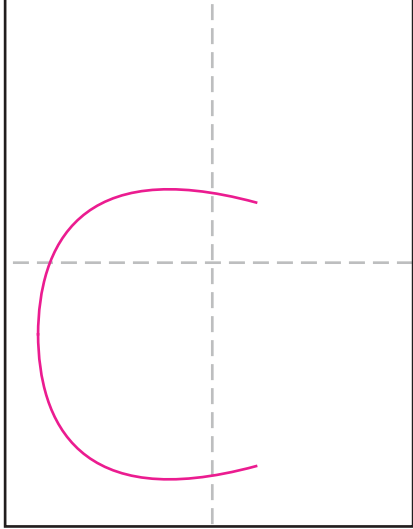
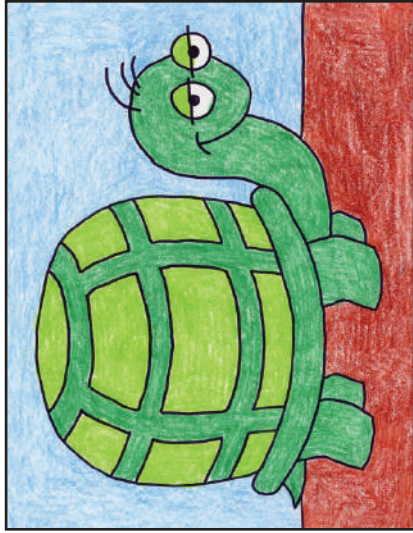

1. Make guide lines. Start turtle shell.

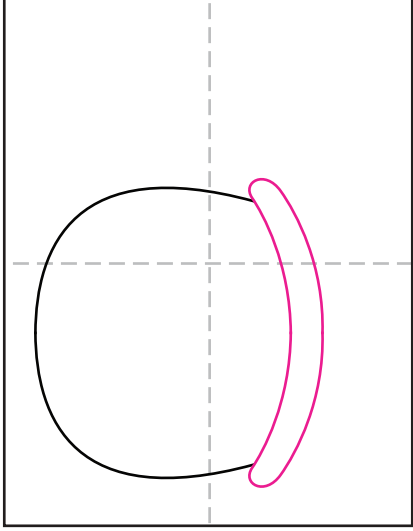

2. Draw bottom edge of shell.

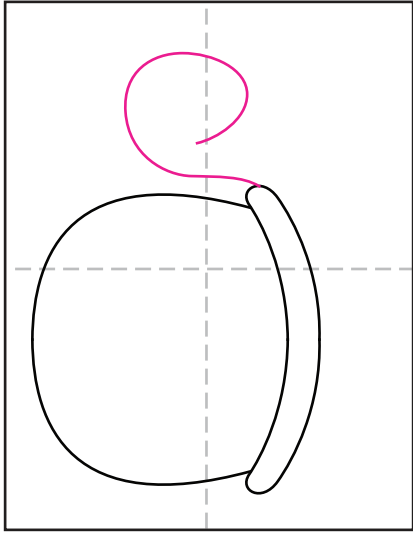

3. Draw the turtle head.

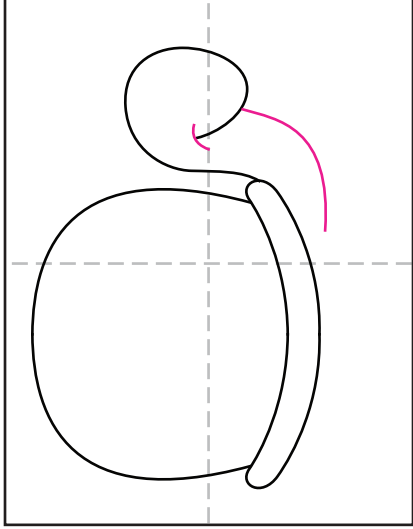

4. Draw the turtle neck.

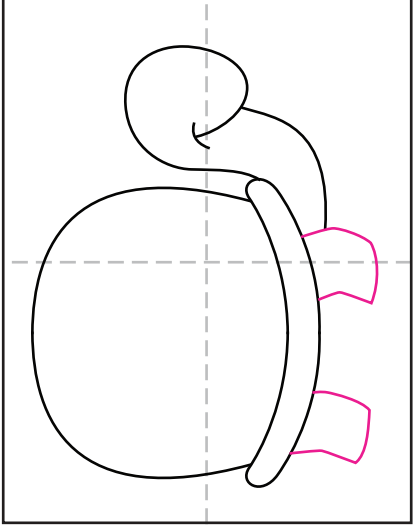

5. Draw two legs.

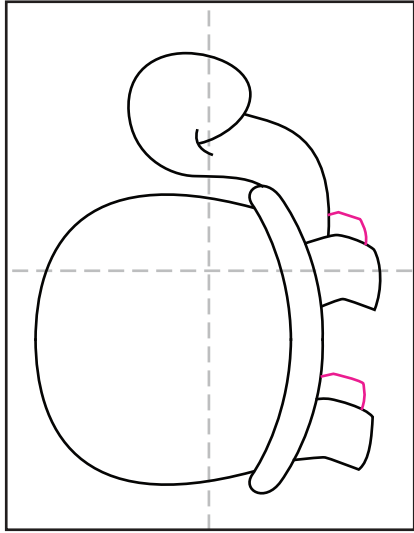

6. Draw back two legs.

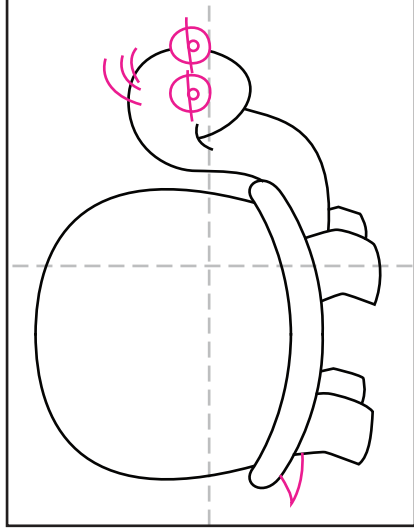

7. Add eyes, hair and tail.

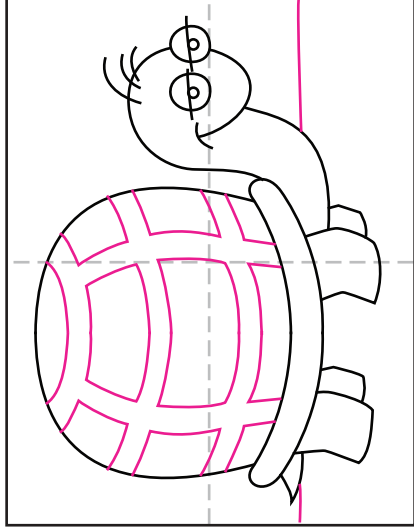

8. Finish with shell pattern and horizon line.

Creative Face Drawing

1. Start with basic shape

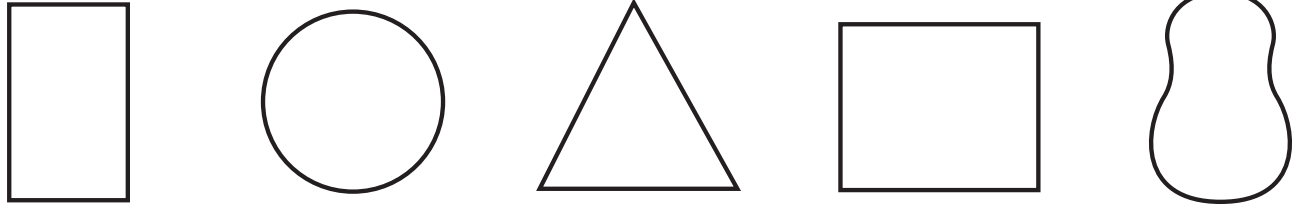

2. Round the corners

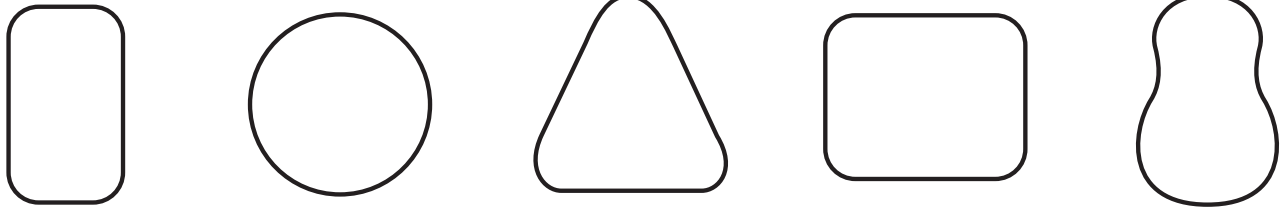

3. Add ears

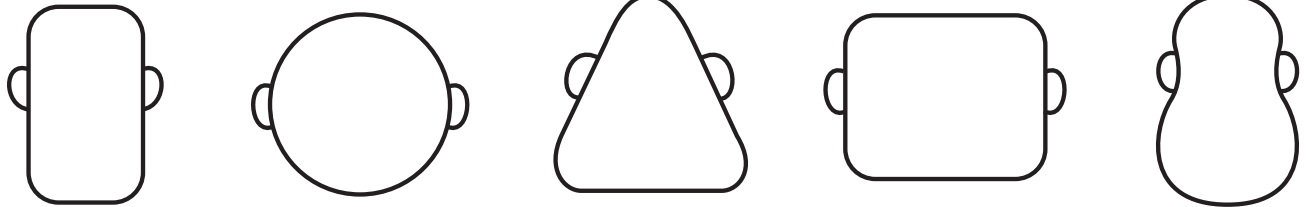

4. Add hair

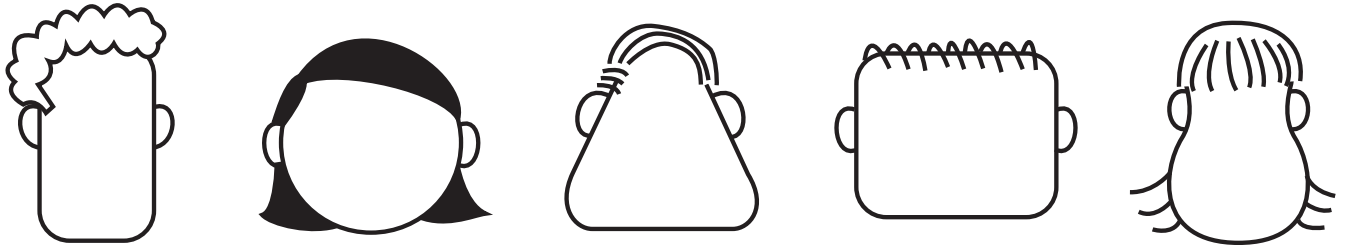

5. Add eyes, nose and mouth



6. Add color. Congratulations, you're a cartoonist!



