

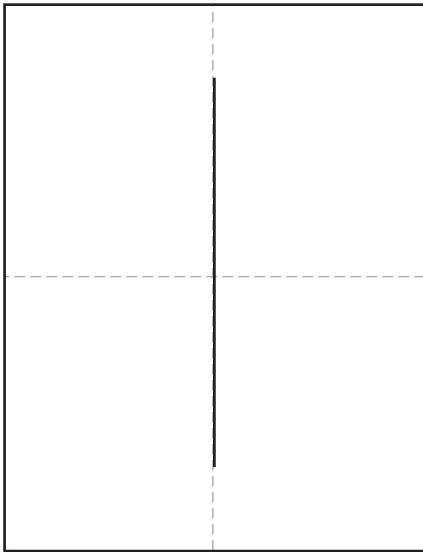

Make a Maple Leaf

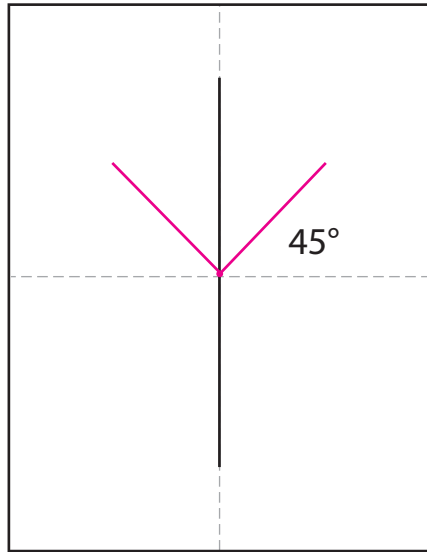

Supplies: Crayola Color Sticks, brown paper, marker, scissors 1. Draw a line.



2. Draw two diagonal lines at a 45 degree angle.

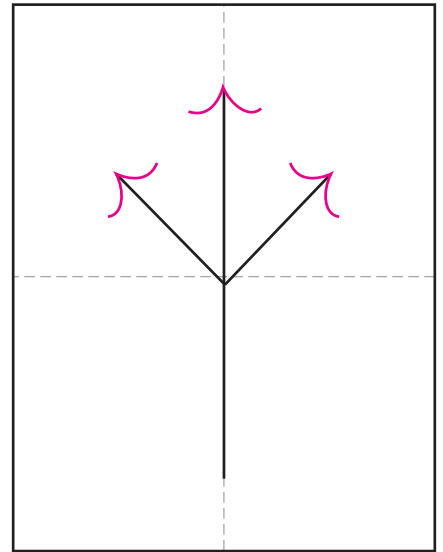

3. Draw "caps" on each end point.

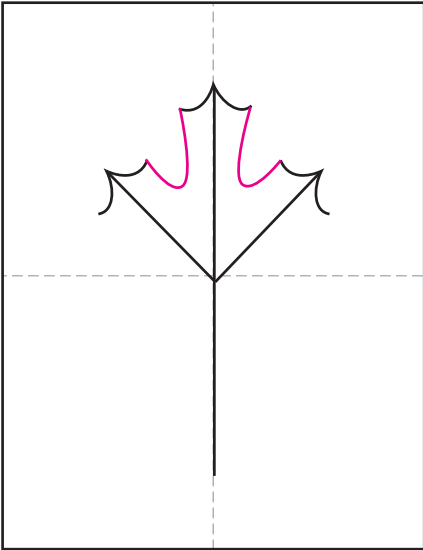

4. Draw a "J" and backwards "J" on each space shown.

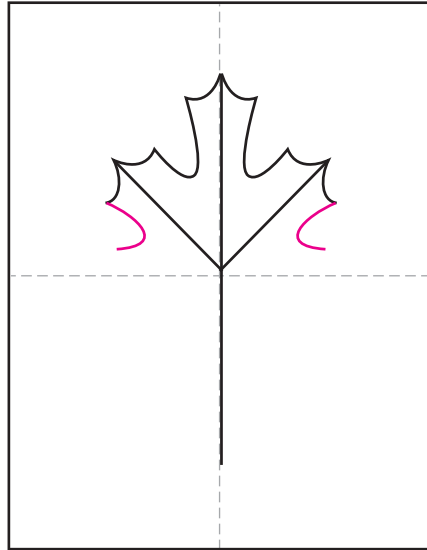

5. Draw two more "J"s as shown.

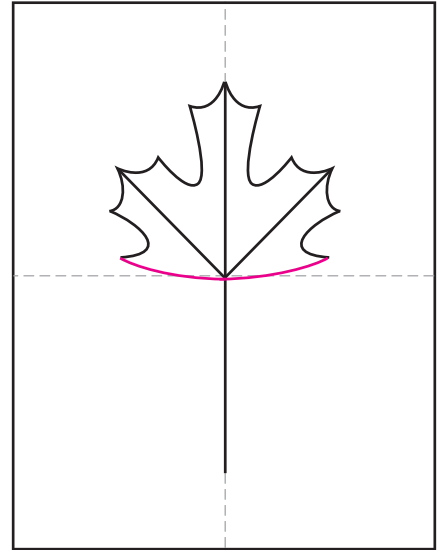

6. Connect the bottom with curves.

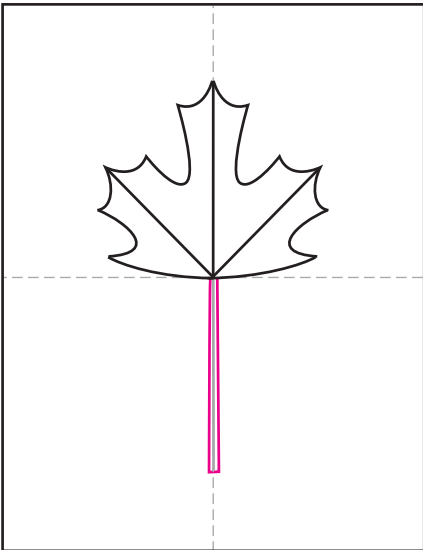

7. Add width to the stem.



8. Trace and color heavily with Crayola Color Sticks.



9. Cut out and display.