

Draw a Toucan

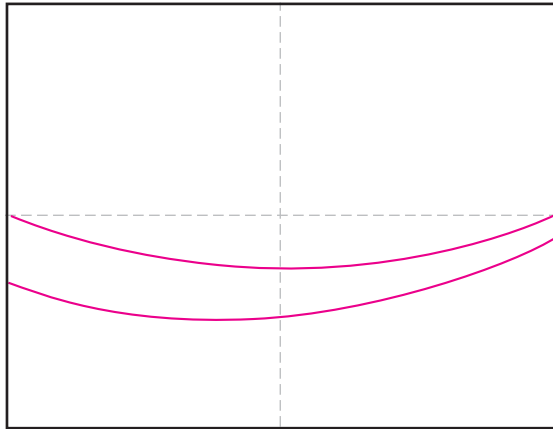

1. Draw a curvy branch.

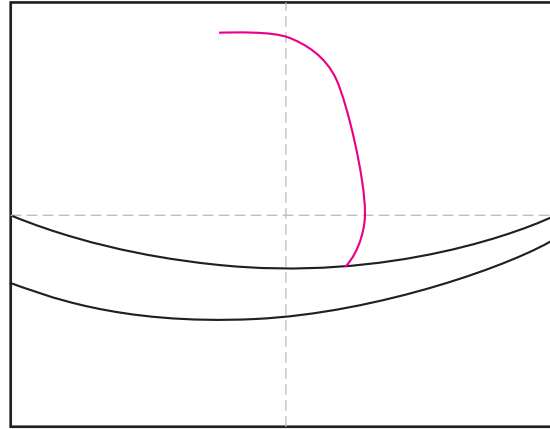

2. Draw one side of the body.

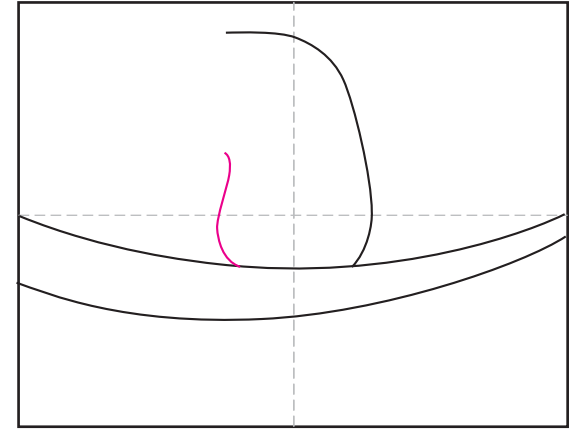

3. Draw the other side, with opening for beak.

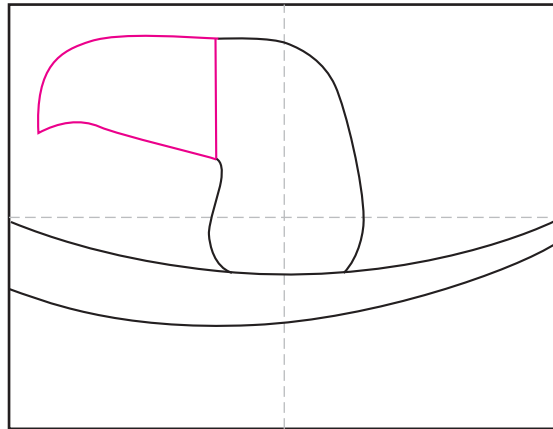

4. Attach a large beak.

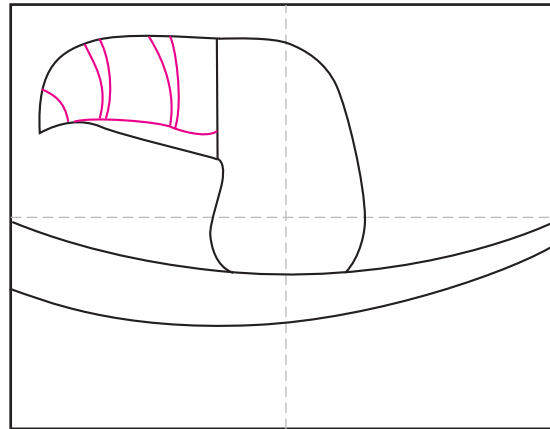

5. Add the beak details shown.

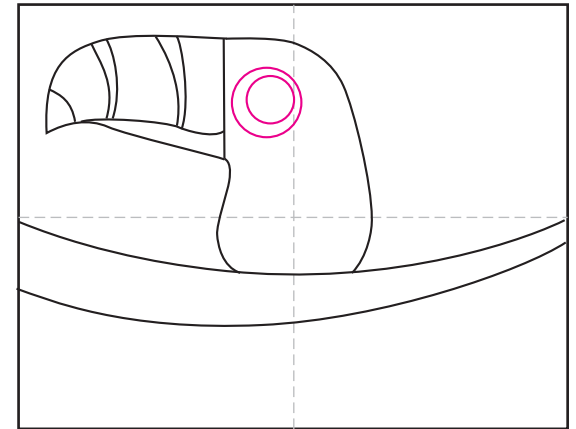

6. Draw two circles for the eye.

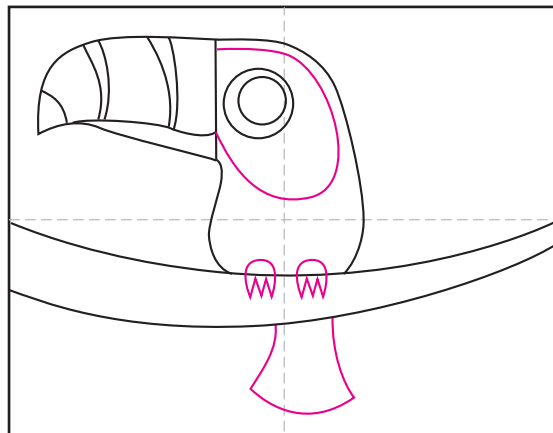

7. Add line around the eye, claws and tail.

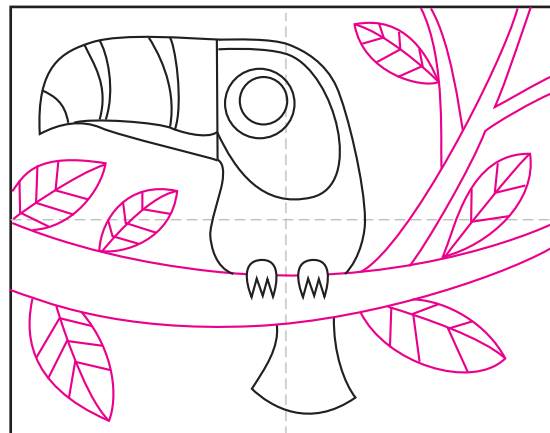

8. Fill the background with branches, leaves.



9. Trace with a marker and color.

