

# Art Journal Scarecrow Face

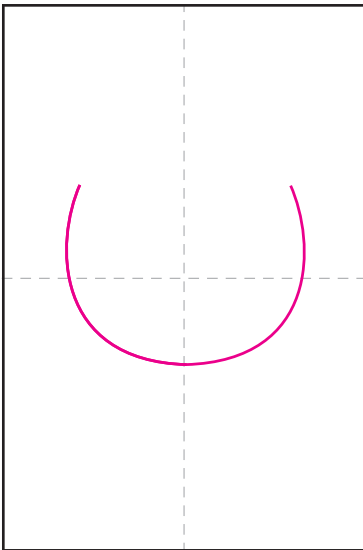

# Art Journal Scarecrow Face Tutorial



1. Draw a large U shape.

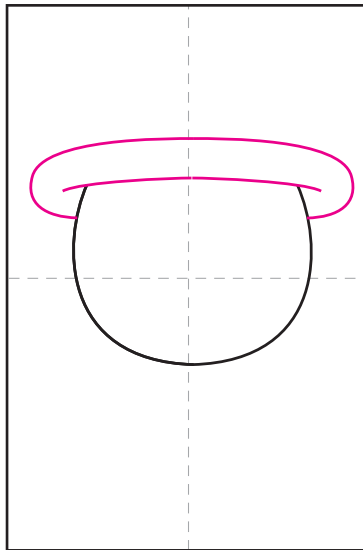

2. Add a rim on top.

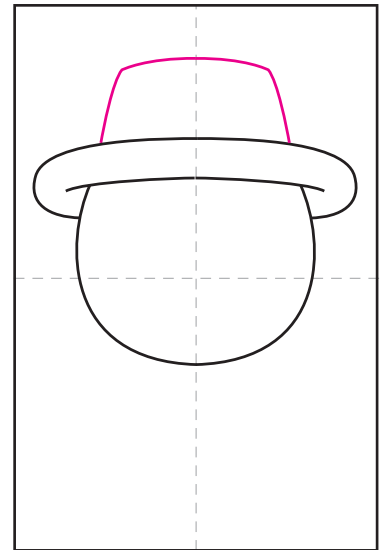

3. Draw the top of the hat.

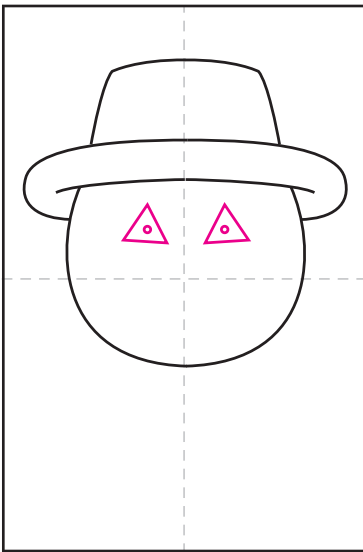

4. Draw two triangle eyes.

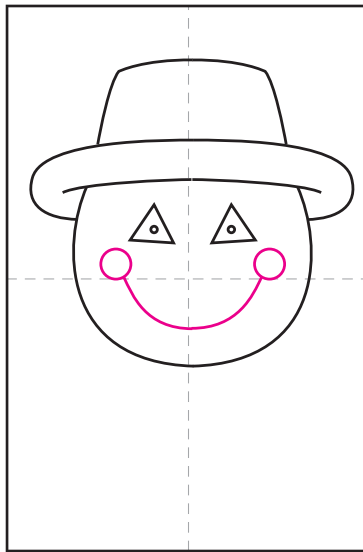

5. Add a large smile.

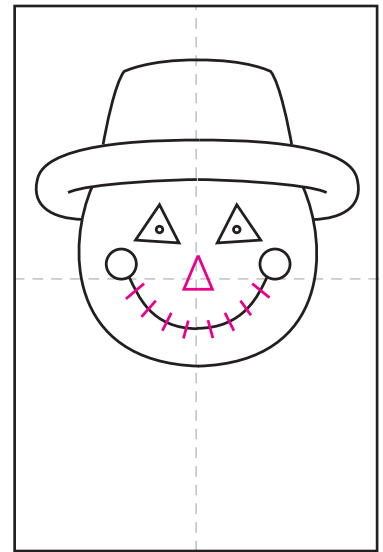

6. Finish with nose and stitch lines.

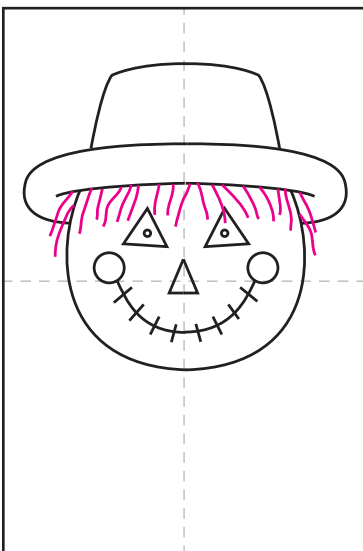

7. Draw straw hair.

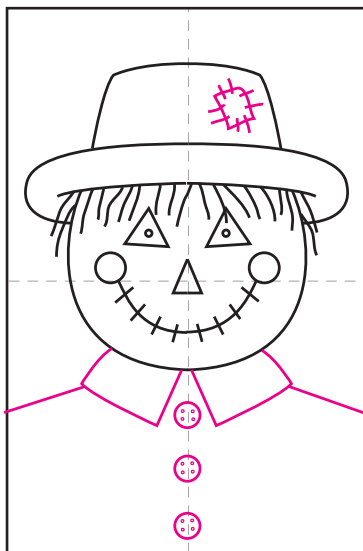

8. Add shirt, buttons and patches.



9. Trace with a marker and color.

# Scarecrow Face



# Scarecrow Face Tutorial

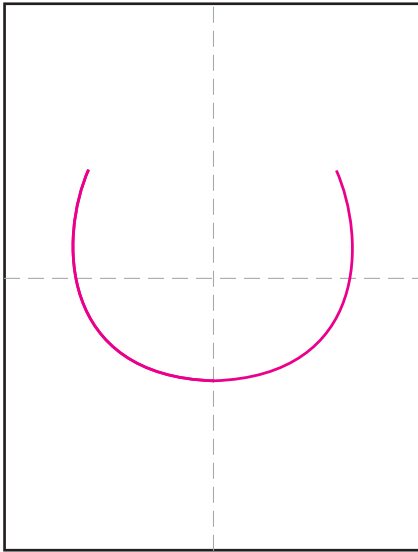

1. Draw a large U shape.

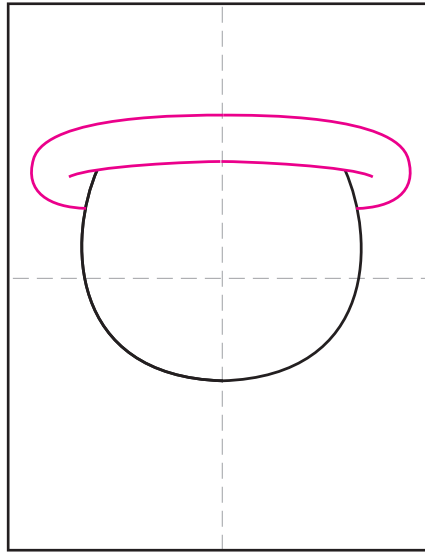

2. Add a rim on top.

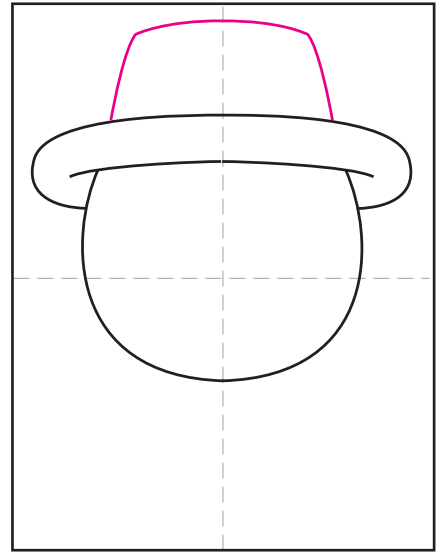

3. Draw the top of the hat.

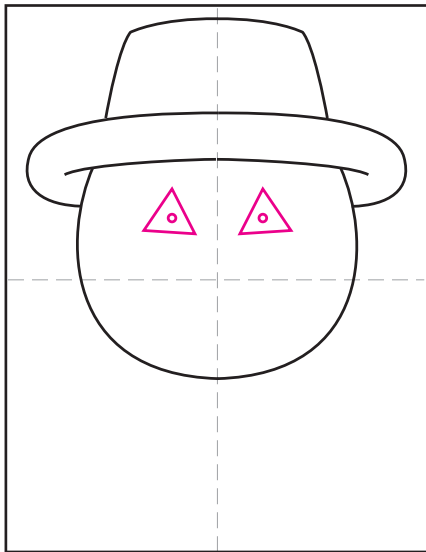

4. Draw two triangle eyes.

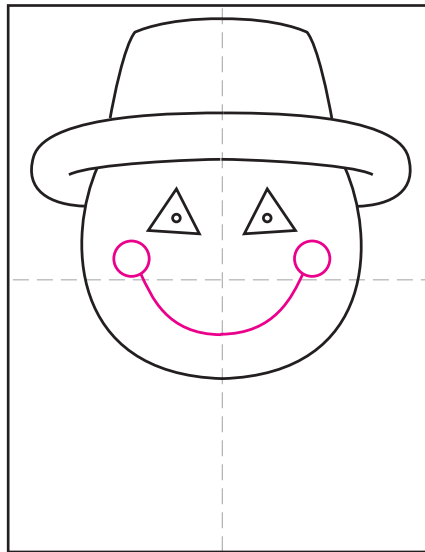

5. Add a large smile.

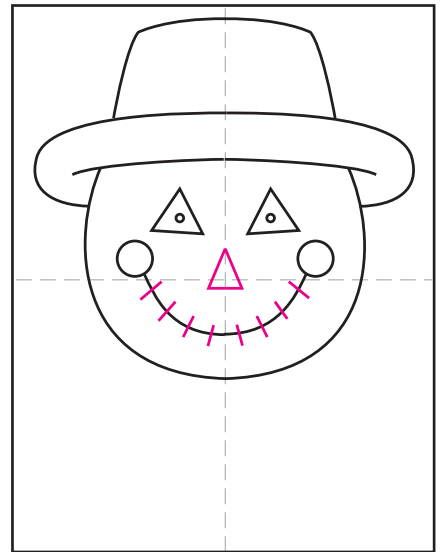

6. Finish with nose and stitch lines.

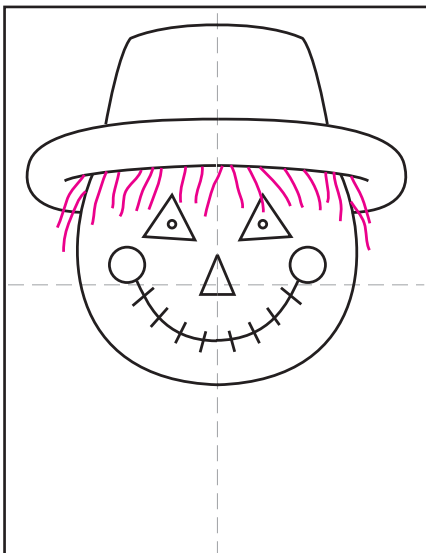

7. Draw straw hair.

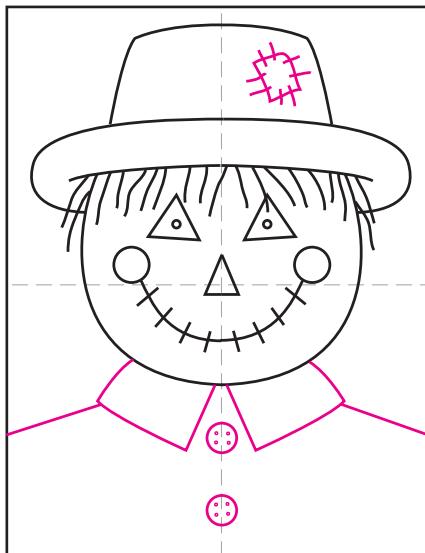

8. Add shirt, buttons and patches.



9. Trace with a marker and color.